

# PWP2008 WATER PUMP CATALOGUE

## ALFA ROMEO

Make & Model	Eng Size	Type	Eng Model	Year	Part No.
<b>Alfa 33</b>					
Alfa 33	1.5L		AS, AR	5/1984 - 89	<b>PWP982</b>
Alfa 33	1.7L		AR	10/1987 - 92	<b>PWP982</b>
<b>Alfa 75</b>					
Alfa 75	2.5, 3.0L	DOHC	AR119, 195	10/1986 - 92	<b>PWP1425</b>
Alfa 75 Twin Spark	2.0L	DOHC	AR062	1/1988 - 92	<b>PWP2369</b>
<b>Alfa 90</b>					
Alfa 90	2.5L	DOHC	AR119	7/1985 - 88	<b>PWP1425</b>
<b>Alfa 147</b>					
Alfa 147	2.0L	DOHC	AR32310	09/2001 on	<b>PWP8010</b>
<b>Alfa 156</b>					
Alfa 156 JTS & Sportwagon	2.0L	DOHC	AR32310	08/2002 on	<b>PWP8010</b>
<b>Alfa 164</b>					
Alfa 164	3.0L	DOHC	AR064	4/1985 - 86	<b>PWP2961</b>
<b>Alfa 166</b>					
Alfa 166	2.0L	Quad Cam		08/2002 on	<b>PWP8010</b>
<b>Alfasud</b>					
Alfasud	1.2, 1.5L		AS, AR	4/1974 - 88	<b>PWP982</b>
<b>Alfetta, Guilietta</b>					
Alfetta, Guilietta	1.8L	DOHC	AR016	4/1974 - 78	<b>PWP1554</b>
Alfetta, Guilietta (With electronic speedo)	2.0L		AR162	3/1984 - 85	<b>PWP2366</b>
<b>GTV</b>					
GTV 2.0 (With electronic speedo)	2.0L		AR016	7/1981 - 86	<b>PWP2366</b>
GTV6, GTV2.5	2.5L	DOHC	AR119	4/1975 - 86	<b>PWP1425</b>
Alfa GTV	2.0L	Twin Spark		07/1999 on	<b>PWP8010</b>



## AUDI

Make & Model	Eng Size	Type	Eng Model	Year	Part No.
--------------	----------	------	-----------	------	----------

### 80

80 Fox (Pump only)	1.3,1.5,1.6L			1972-79	<b>PWP952</b>
80 Fox (Pump only)	1.8, 2.0L			1/86-94	<b>PWP2453</b>
80	2.3L		NG	8/92-94	<b>PWP2645</b>
80	2.6,2.8L	V6	ABC,AAH	8/92-95	<b>PWP3134</b>

### 90

90 Sport	2.3L		NG	5/89-92	<b>PWP2645</b>
----------	------	--	----	---------	----------------

### 100

100 LS	1.8,1.9L			1970-76	<b>PWP908</b>
100 Fox (Pump only)	1.6,1.8,1.9L			1974-76	<b>PWP952</b>
100	2.1,2.2L			12/83-87	<b>PWP2226</b>
100	2.3L		NF	1/88-91	<b>PWP2645</b>
100	2.6,2.8L	V6	ABC,AAH	1/92-94	<b>PWP3134</b>

### 200

200 Turbo	2.2L		KG, KJ	5/1982 - 84	<b>PWP2226</b>
200 Turbo	2.2L		MC	1/1986 - 91	<b>PWP2645</b>

### A3

A3	1.6L		AEH	5/1997 on	<b>PWP7079</b>
A3 1.8i 20V, Inc. Turbo	1.8L	DOHC	AGN, AGU	5/1997 on	<b>PWP7078</b>
A3 1.6i	1.6L	DOHC	BGU	2003 on	<b>PWP7079</b>

### A4

A4 Inc 30V	2.4,2.6L	V6	AGA, ABC	5/1995 - 3/98	<b>PWP7088</b>
A4 Inc Quattro V6	2.6L	SOHC	ABC	8/1995 - 3/98	<b>PWP7088</b>
A4	1.8L	DOHC	AJL, AVJ	5/1995 - 1/01	<b>PWP7090</b>
A4 With Auto / Tiptronic	2.6, 2.8L	V6	AAH, ACK	9/1995 - 6/01	<b>PWP7088</b>
A4 Avant, Quattro 20V V6	1.6,1.8L	DOHC	ADR, AFY	5/1995 - 1/01	<b>PWP4003</b>
A4 B6	1.8L	Turbo	AVJ	2/2001 - 04	<b>PWP7078</b>
A4 B6	2.0L		ALT	7/2001 on	<b>PWP7087</b>
A4 B6	2.4L	V6	ASN	4/2002 on	<b>PWP7088</b>

### A6

A6 Inc Quattro 20V	1.8L	DOHC	ADR	11/1994 on	<b>PWP4003</b>
A6 Inc Quattro 30V V6	2.4,2.6L	DOHC	ABC, AAH	11/1994 -10/97	<b>PWP7088</b>
A6 Inc Quattro V6	2.6,2.8L	SOHC, DOHC	ABC, AAH	5/1997 -12/98	<b>PWP7088</b>
A6	4.2L	V8	AEC, AHK	10/1997 on	<b>PWP3329</b>
A6 Inc Quattro 30V V6	2.4L	DOHC	ALW. ARN	1998 - 04	<b>PWP7081</b>
A6	2.7L	V6 Bi-turbo	ARE	1/2004 on	<b>PWP5004</b>
A6 - C6	3.0L	V6	ASN	01/02 on	<b>PWP8006</b>

# PWP2008 WATER PUMP CATALOGUE

**AUDI**













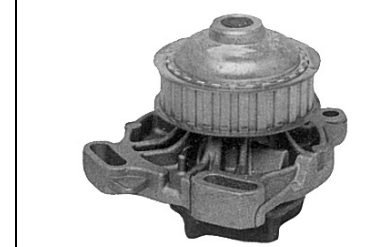

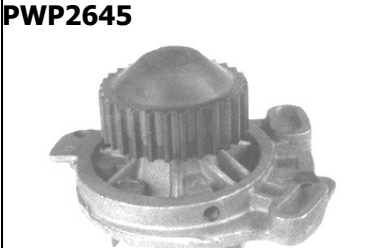
Make & Model	Eng Size	Type	Eng Model	Year	Part No.
<b>A8</b>					
A8 Inc Quattro V6	2.8L	SOHC,DOHC	ACK	06/94-9/98	<b>PWP7088</b>
A8	2.8L	V6	AAH	5/95 on	<b>PWP7088</b>
A8	4.2L	V8	ABZ	5/95 on	<b>PWP3329</b>
A8 - D8	3.0L	V6	ASN	09/03 on	<b>PWP8006</b>

## Quattro

Quattro 20V	2.2L		KZ	8/1984 - 7/90	<b>PWP2226</b>
Quattro	2.3L		NF	8/1986 - 11/90	<b>PWP2226</b>
Quattro V8	3.6L	DOHC	PT	11/1990 on	<b>PWP3329</b>

## TT

Coupe 1.8i 20V Turbo	1.8L	DOHC	APX	6/1999 - 00	<b>PWP7078</b>
----------------------	------	------	-----	-------------	----------------

<b>PWP908</b> 	<b>PWP952</b> 	<b>PWP2226</b> 	<b>PWP2453</b> 
<b>PWP2645</b> 	<b>PWP3134</b> 	<b>PWP3329</b> 	<b>PWP4003</b> 
<b>PWP5004</b> <i>Photo Not Available</i>	<b>PWP7078</b> 	<b>PWP7079</b> 	<b>PWP7081</b> 
<b>PWP7087</b> 	<b>PWP7088</b> 	<b>PWP7090</b> 	<b>PWP8006</b> <i>Photo Not Available</i>

## BEDFORD

Make & Model	Eng Size	Type	Eng Model	Year	Part No.
<b>BEDFORD</b>					
HAE, HAV Vans 92000 series	4 Cyl.			1964 - 67	<b>PWP786</b>
CF, EF Eng. No 6032382-on	200, 220, 330	Petrol and Diesel		1968 - 77	<b>PWP935</b>
CF, Van 6 Cyl.	173, 202	(Holden eng.)		1976 - 80	<b>PWP814</b>

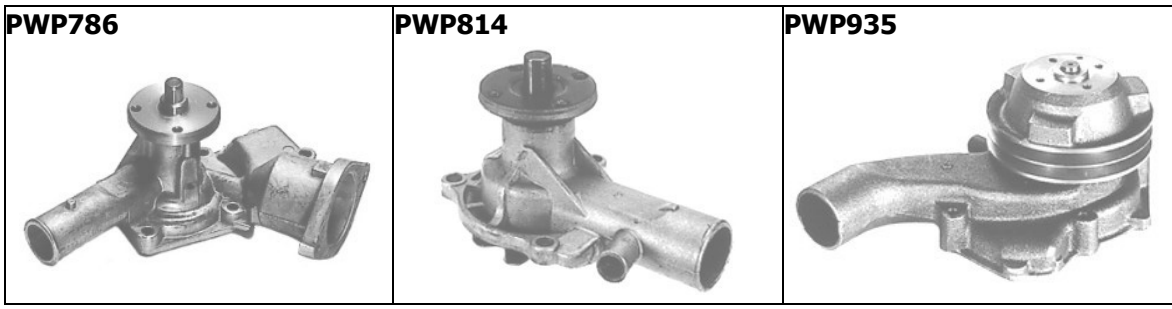

## BMW

Make & Model	Eng Size	Type	Eng Model	Year	Part No.
<b>Early Series</b>					
1500,1502,1600,1602,1800				1963 - 77	<b>PWP561</b>
1800Ti,2000,2000Ti,2002,2002Ti				1963 - 77	<b>PWP561</b>
2500,2800,3.0S,3.0Si,3.3L				1968 - 78	<b>PWP760</b>

### 3 Series E21

318i	1.8L		M10	3/1980 - 12/83	<b>PWP990</b>
320, 320i	2.0L		M10	3/1976 - 82	<b>PWP990</b>
320i	2.3L		M20	1981 - 87	<b>PWP2154</b>
323i (Conventional fan)	2.3L		M20	1979 - 81	<b>PWP1559</b>
323i (With fan clutch)	2.3L		M20	1981 - 87	<b>PWP2154</b>
325	2.7L		M20	1986 - 87	<b>PWP2154</b>

### 3 Series E30

316i	1.6L		M40	5/1987 - 10/94	<b>PWP2671</b>
318i	1.8L		M10	1983 - 9/88	<b>PWP2358</b>
318i	1.8L		M40	1/1987 - 10/94	<b>PWP2671</b>
318iS	1.8L	16V DOHC	M42	1988 - 90	<b>PWP7130</b>
320i	2.0L		M20	2/1988 - 94	<b>PWP2646</b>
325	2.7L		M30	1985 - 87	<b>PWP2154</b>
325i	2.5L		M20	1985 - 10/94	<b>PWP2646</b>

# PWP2008 WATER PUMP CATALOGUE

**BMW**

Make & Model	Eng Size	Type	Eng Model	Year	Part No.
--------------	----------	------	-----------	------	----------

## 3 Series E36

316i	1.6L		M40	9/1990 - 7/94	<b>PWP3130</b>
316i	1.6L		M43	3/1993 - 7/99	<b>PWP7130</b>
318i	1.8L	SOHC	M43	4/1990 - 11/99	<b>PWP3130</b>
318i	1.8L	SOHC	M44	8/1993 on	<b>PWP7130</b>
320i	2.0L		M50	11/95 - 9/99	<b>PWP2735</b>
323i	2.5L	DOHC	M52	8/1994 - 11/99	<b>PWP2735</b>

## 3 Series E46

316i	1.9L		M43	8/1998 - 6/01	<b>PWP7130</b>
318iS	1.9L	16V DOHC	M43	6/1998 on	<b>PWP7130</b>
318d	2.0L	Diesel	M47	7/2001 on	<b>PWP7140</b>
320i	2.0, 2.2L	16V DOHC	M52, M54	2/1998 on	<b>PWP2735</b>
320d	2.0L	Diesel	M47	7/2001 on	<b>PWP7140</b>
323i	2.5L		M52, M54	9/1998 on	<b>PWP2735</b>

## 5 Series E12

520	2.0L		M10	1973 - 1/79	<b>PWP990</b>
520i	2.0L		M20	8/1977 - 4/81	<b>PWP1559</b>
525,528i	2.8L		M20	10/1973 - 3/78	<b>PWP760</b>
528i (Screw type pulley)	2.8L		M30	4/1978 - 5/81	<b>PWP2477</b>
535i	3.4L		M30	8/1980 - 3/81	<b>PWP2477</b>

## 5 Series E28

520,525i (With fan clutch)	2.0, 2.7L		M20	1981 - 87	<b>PWP2154</b>
525i	2.5L		M20	9/1988 - 90	<b>PWP2646</b>
528i (Screw type pulley)	2.8L		M20	6/1981 - 11/87	<b>PWP2477</b>
535i, M535i (Screw type pulley)	3.5L		M20	1/1985 - 2/88	<b>PWP2477</b>

## 5 Series E34

518i	1.8L		M40	4/1989 - 10/92	<b>PWP2671</b>
518i	1.8L		M40	4/1993 on	<b>PWP3130</b>
518i	1.8L		M43	1992 - 1/97	<b>PWP7130</b>
520i	2.0L		M20	1/1988 - 10/90	<b>PWP2646</b>
520i	2.0L	DOHC	M50	11/1990 - 1/97	<b>PWP2735</b>
525i	2.5L	DOHC	M50	11/1990 - 96	<b>PWP2735</b>
525i	2.5L		M20	9/1988 - 90	<b>PWP2646</b>
530i	3.0L		M30	1/88 - 2/92	<b>PWP2477</b>
530i	3.0L	DOHC V8	M60	6/1993 - 96	<b>PWP4006</b>
535i	3.5L		M30	2/1988 - 10/95	<b>PWP2477</b>
540i	4.0L	DOHC V8	M60	3/1992 - 1/97	<b>PWP4006</b>

## BMW

Make & Model	Eng Size	Type	Eng Model	Year	Part No.
--------------	----------	------	-----------	------	----------

### 5 Series E39

525i	2.5L	DOHC	M54	05/96-10/03	<b>PWP2735</b>
528i	2.8L	DOHC	M54	05/96-10/03	<b>PWP2735</b>
530i	3.0L	DOHC	M54	05/96-10/03	<b>PWP2735</b>
535i	3.5L	V8	M54	05/96-10/03	<b>PWP8008</b>
540i	4.0L	32V DOHC	M62	05/96-01/98	<b>PWP2735</b>
540i	4.0L	32V DOHC	M62	01/98-10/03	<b>PWP9002</b>

### 5 Series E60

525i	2.5L	DOHC	M54	10/03 on	<b>PWP2735</b>
530i	3.0L	DOHC	M54	10/03 on	<b>PWP2735</b>
545i	4.4L	32V DOHC		10/03 on	<b>PWP8008</b>

### 6 Series E24

628i	2.8L		M20	8/1979 - 5/87	<b>PWP2477</b>
630	3.0L		M30	2/1976 - 8/79	<b>PWP760</b>
633 (Fixed fan)	3.4L		M30	2/1976 - 8/79	<b>PWP760</b>
633i	3.2L		M30	1979 - 81	<b>PWP2477</b>
635i	3.4L		M30	5/1986 - 89	<b>PWP2477</b>

### 7 Series

733i E23 (Fixed fan)	3.2L	6	M30	1980 - 83	<b>PWP760</b>
735i E28	3.4L	6	M30	3/1985 - 92	<b>PWP2477</b>
750i E31 & E32	5.0L	V12	M70	10/1988 - 95	<b>PWP4007</b>
730i E32	3.0L	V8	M60	11/1990 - 10/94	<b>PWP4006</b>
740i E32	4.0L	V8	M60	1992 - 94	<b>PWP4006</b>
735i E34 (Screw type pulley)	3.4L	6	M30	1983 - 85	<b>PWP2477</b>
730i E38	3.0, 4.0L	DOHC V8	M60	1992 - 93	<b>PWP4006</b>
735i E38	3.5L	DOHC V8	M60	1995 - 98	<b>PWP6006</b>
740i E38	4.4L	DOHC V8	M60	1996 - 98	<b>PWP6006</b>

### 8 Series

840i E31	4.0L	V8	M60	1993 - 98	<b>PWP4006</b>
840i E31	4.4L	V8	M60	1993 - 95	<b>PWP6006</b>
850i E31	5.0L	V12	M70	10/1988 - 95	<b>PWP4007</b>

### Mini

Mini W10B16	1.6L	DOHC		4/01 on	<b>PWP7199</b>
-------------	------	------	--	---------	----------------

### X3 Series

X3 E83	2.5L	24V DOHC		06/04 on	<b>PWP2735</b>
X3 E83	3.0L	24V DOHC		06/04 on	<b>PWP2735</b>

# PWP2008 WATER PUMP CATALOGUE

**BMW**



Make & Model	Eng Size	Type	Eng Model	Year	Part No.
<b>X5 Series</b>					
X5 E53 4x4	3.0L	DOHC	M54	11/00-12/06	<b>PWP2735</b>
X5 E53 4x4 Inc. Turbo	3.0L	Diesel	M57	11/00-12/06	<b>PWP2745</b>
X5 E53 4x4	4.4L	V8		11/00-12/06	<b>PWP9002</b>
X5 E70 4x4 Inc. Turbo	3.0L	Diesel	M57	03/07 on	<b>PWP2745</b>

## Z Series

Z1 Coupe	2.5L		M20B	11/1988 - 10/91	<b>PWP2646</b>
Z3 Convertible 16V	1.8L	OHC	M42B	2/1997 - 9/02	<b>PWP7130</b>
Z3 Convertible 16V	1.9L	DOHC	M44	2/1997 - 6/99	<b>PWP7130</b>
Z3 Convertible 24V	2.0L	DOHC	M52	6/1999 - 11/00	<b>PWP2735</b>
Z3 Convertible 24V	2.8L	DOHC	M52	2/1997 - 8/00	<b>PWP2735</b>
Z3 Convertible 24V	3.0L	DOHC	M52	2/1997 - 8/00	<b>PWP2735</b>
Z3 Convertible 24V	3.2L	DOHC	S54	2/1997 - 9/02	<b>PWP7327</b>
Z4 Convertible	2.5L	DOHC		08/03 on	<b>PWP2735</b>
Z4 Convertible	3.0L	DOHC		08/03 on	<b>PWP2735</b>



## BMW

Make & Model	Eng Size	Type	Eng Model	Year	Part No.
<b>PWP4006</b> 	<b>PWP4007</b> 	<b>PWP6006</b> 	<b>PWP7130</b> 		
<b>PWP7140</b> 	<b>PWP7199</b> <i>Photo Not Available</i>	<b>PWP7327</b> 	<b>PWP8008</b> 		
<b>PWP9002</b> 					

## CHRYSLER

Make & Model	Eng Size	Type	Eng Model	Year	Part No.
<b>Centura</b>					
KB & KC Hemi eng.	215, 245	Hemi Engine		1975 - 78	<b>PWP802</b>
<b>Neon</b>					
Neon	2.0L		S4RE	1995 - 8/99	<b>PWP3021</b>
<b>PT Cruiser</b>					
PT Cruiser	2.0L		1T	8/2000 on	<b>PWP3021</b>
PT Cruiser (Excluding Turbo)	2.4L		4W	2001 on	<b>PWP4023</b>
<b>Valiant</b>					
RV1, SV1, AP5, AP6, VC, VE, VF, VG		225 Slant engine		1962 - 70	<b>PWP578</b>
VG, VH, VJ, VK, CH, CJ, CK, CL, CM	215, 245, 265	Hemi engine		1971 - 81	<b>PWP802</b>
AP6, VC, VE, VF		273, 318cid		1965 - 70	<b>PWP2919</b>
VG,VH,VJ,VK,CL,CM (W/o air or thermal drive)		318, 340, 360cid		1970 - 81	<b>PWP806</b>
VG,VH,VJ,VK,CL,CM (W/o air with thermal drive)		318, 340, 360 cid		1970 - 81	<b>PWP899</b>
VG,VH,VJ,VK,CL,CM (With air & thermal drive)		318, 340, 360cid	<b># NOTE:</b>	1970 - 81	<b>PWP2010</b>

**# NOTE:** Hub needs to be replaced on the above



# PWP2008 WATER PUMP CATALOGUE

## CHRYSLER







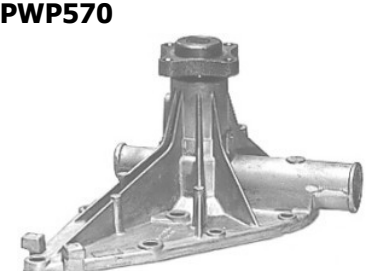

Make & Model	Eng Size	Type	Eng Model	Year	Part No.
--------------	----------	------	-----------	------	----------

### Voyager

SE Wagon	3.3L	V6	VU	3/97- 3/01	<b>PWP6002</b>
SE Wagon	3.3L	V6	VU	5/2001 on	<b>PWP1002</b>

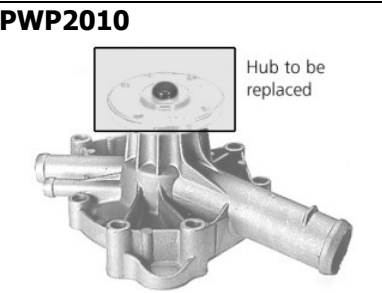
### CHRYSLER - UK

Hillman Hunter, Arrow		1725cc		1967 - 76	<b>PWP570</b>
Humber Vogue, Sceptre				1967 - 76	<b>PWP570</b>
Singer Gazelle				1967 - 70	<b>PWP570</b>
Sunbeam Alpine				1969 - 76	<b>PWP570</b>

<b>PWP570</b> 	<b>PWP578</b> 	<b>PWP802</b> 	<b>PWP806</b> 
<b>PWP899</b> <p style="text-align: center;"><i>Photo Not Available</i></p>	<b>PWP1002</b> <p style="text-align: center;"><i>Photo Not Available</i></p>	<b>PWP2010</b>  <p style="text-align: right; font-size: small;">Hub to be replaced</p>	<b>PWP2919</b> 
<b>PWP3021</b> 	<b>PWP4023</b> 	<b>PWP6002</b> 	

## CITROEN

Make & Model	Eng Size	Type	Eng Model	Year	Part No.
--------------	----------	------	-----------	------	----------

### AX

AX14	1.4L		T43	1/1991 - 93	<b>PWP4025</b>
------	------	--	-----	-------------	----------------

### Berlingo

Berlingo 1.4i	1.4L	OHC	DW8	7/1999 on	<b>PWP7999</b>
Berlingo 1.4i	1.4L	OHC	ET3	2003 on	<b>PWP8001</b>
Berlingo 1.9HDi	1.6L	OHC	DW8	7/1998 on	<b>PWP7069</b>
Berlingo 2.0HDi	2.0L	OHC	DW10	8/1999 on	<b>PWP7069</b>

### C2

C2	1.6L	DOHC	TU5JP4	03/04 on	<b>PWP7301</b>
----	------	------	--------	----------	----------------

### C3

C3	1.4L	16V DOHC	TU3JP	09/02 on	<b>PWP7999</b>
C3	1.6L	DOHC	TU5JP4	09/02 on	<b>PWP7301</b>

### C4

C4	2.0L	DOHC		03/05 on	<b>PWP7310</b>
C4	2.0L	DOHC	EW	2004 on	<b>PWP8309</b>

### C5

C5	2.0L	DOHC		06/01-12/04	<b>PWP7310</b>
C5	2.0L	16V	EW	2001 on	<b>PWP8309</b>
C5 Turbo	2.0L	Diesel		06/01-12/04	<b>PWP7069</b>

### Xantia

Xantia Inc. Turbo	2.0L	OHC	XU	9/94 - 12/00	<b>PWP4028</b>
Xantia 16V	2.0L	DOHC	XU	6/95 - 12/00	<b>PWP7039</b>
Xantia	3.0L	V6	ES	3/98 - 12/00	<b>PWP7041</b>

### Xsara

Xsara	1.6L		TU	8/1998 on	<b>PWP4025</b>
Xsara	1.8L		TU	8/1998 on	<b>PWP2891</b>
Xsara	1.8L	DOHC	XU	8/1998 on	<b>PWP7044</b>
Xsara 16V	2.0L		XU	8/1998 on	<b>PWP7039</b>

**PWP2891**



**PWP4025**

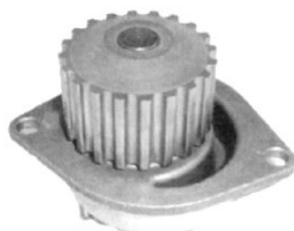

**PWP4028**







**PWP7039**



# PWP2008 WATER PUMP CATALOGUE

## CITROEN

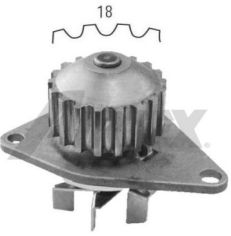
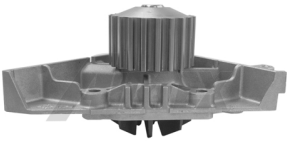
Make & Model	Eng Size	Type	Eng Model	Year	Part No.
<b>PWP7041</b> 	<b>PWP7044</b> 	<b>PWP7069</b> 	<b>PWP7301</b> 		
<b>PWP7310</b> 	<b>PWP7999</b> 	<b>PWP8309</b> 			

## DAEWOO

Make & Model	Eng Size	Type	Eng Model	Year	Part No.
<b>1.5i</b>					
Sedan (With shield)	1.5L	SOHC	G15MF	7/1994 - 10/95	<b>PWP3074</b>
<b>Cielo</b>					
Hatch (Without shield)	1.5L	SOHC	G15MF	1994 on	<b>PWP3071</b>
Hatch	1.5L	DOHC	V15L	1995 - 98	<b>PWP7000</b>
<b>Espero</b>					
Sedan	2.0L		CJ20E	1995 - 97	<b>PWP9076</b>
<b>Lacetti</b>					
J200	1.8L	DOHC	X18SED	10/2003 on	<b>PWP7031</b>
<b>Lanos</b>					
Hatch	1.5L	SOHC	A15MF	8/1997 - 3/03	<b>PWP3071</b>
Hatch	1.6L	DOHC	A16MF	8/1997 - 3/03	<b>PWP7000</b>
<b>Leganza</b>					
Sedan	2.0L		C20	1997 - 4/99	<b>PWP7031</b>
Sedan	2.2L		T22	5/1999 on	<b>PWP7031</b>
<b>Matiz</b>					
Hatch 5 door	796cc		F8CV	10/1999 on	<b>PWP7020</b>

## DAEWOO

Make & Model	Eng Size	Type	Eng Model	Year	Part No.
<b>Nubira</b>					
J100	1.6L	DOHC	A16MF	7/97 - 10/99	<b>PWP7111</b>
J100	2.0L	DOHC	X20	7/97 - 3/99	<b>PWP7031</b>
J150	2.0L	DOHC	X20	4/1999 on	<b>PWP7031</b>

<b>Tacuma</b>					
Wagon	2.0L	DOHC	X20	11/2000 on	<b>PWP7031</b>



## DAIHATSU

<b>Applause</b>					
A101	1.6L		HD-E	1989 - 92	<b>PWP3009</b>

<b>Centro</b>					
MS, MX	660cc		EF	3/1995 - 2/99	<b>PWP3059</b>

<b>Charade</b>					
G10	1.0L		CB	1980 - 83	<b>PWP853</b>
G11, G100, G102, G200	1.0L	Without outlet	CB	1983 - 96	<b>PWP2017</b>
G11, G100, G102, G200	1.0L	With outlet	CB	1985 - 96	<b>PWP2027</b>
G100S	1.0L	Turbo	CB	1987 - 93	<b>PWP101</b>
G102, G200	1.3L		HC-E	1989 - 96	<b>PWP3009</b>
G203	1.3,1.5,1.6L		HC, HD, HE	5/1996 on	<b>PWP3009</b>

<b>Cuore</b>					
L701	1.0L	3 Cyl.	EJ	7/2000 - 10/03	<b>PWP7145</b>

# PWP2008 WATER PUMP CATALOGUE

## DAIHATSU

Make & Model	Eng Size	Type	Eng Model	Year	Part No.
<b>Delta</b>					
Delta	2.8L	Diesel	DL	1977 - 84	<b>PWP5028</b>
DV23	2.0L		5R	1971 - 77	<b>PWP858</b>
DV23, 26T	2.5L	Diesel	DG	1973 - 77	<b>PWP883</b>
DV28	3.0L	Diesel	B	1977 on	<b>PWP885</b>
SV17, 17T	1.6L		12R	1973 - 77	<b>PWP959</b>
V10, 11, 12, 90	3.0L	Diesel	B	1978 on	<b>PWP885</b>
V10, 11, 12, 40, 48, 98	3.2L	Diesel	2B	1980 on	<b>PWP9075</b>
V40, 47, 48, 50, 98	3.0, 3.4L	Diesel	B, 3B	1982 - 84	<b>PWP9075</b>
V54, 55	2.8L	Diesel	DL	1983 - 84	<b>PWP5028</b>
V57, 58	2.8L	Diesel	DL	1985 - 88	<b>PWP3008</b>
V67, 68	2.0L		3Y	1985 - 87	<b>PWP894</b>
V76, 78, 79, 99	3.0, 3.4L	Diesel	3B, 13B	1984 - 95	<b>PWP3038</b>
V107, 108, 109	2.2L		4Y	1988 on	<b>PWP894</b>
<b>Duet</b>					
G30	1.0L		CB	1983-85	<b>PWP2017</b>
<b>F Series</b>					
F20 4WD	1.6L		12R	1973 - 79	<b>PWP959</b>
F20, 25 4WD	1.6L		12R	1979 - 84	<b>PWP882</b>
F50, 55, 60, 65 4WD	2.5, 2.8L	Diesel	DG, DL	1978 - 84	<b>PWP5028</b>
<b>Feroza</b>					
F300	1.6L		HD-E	1989 - 92	<b>PWP3009</b>
F300, 310	1.6L		HD-E	1992 on	<b>PWP3122</b>
<b>Handivan</b>					
L55	0.5L		AB20	1977 - 80	<b>PWP863</b>
L55	0.5L		AB30	5/1981 - 82	<b>PWP1070</b>
L54, 55, 56	0.5L		EB	1980 - 85	<b>PWP9026</b>
L80	0.8L		ED	1986 on	<b>PWP3059</b>
<b>Hijet</b>					
S38V	360cc		ZM	1973 - 77	<b>PWP884</b>
S60, 65	0.5L		AB	1979 - 82	<b>PWP1070</b>
S65, 66	0.5L		AB	1981 - 84	<b>PWP1070</b>
S70, 75, 75T, 85	0.8L, 1.0L		CB, CD	1986 - 90	<b>PWP2027</b>
<b>Mira</b>					
L70, 80	550cc		EB	1986 on	<b>PWP9029</b>
L200, 201	659, 847cc		ED, EF-EL	1990 on	<b>PWP3059</b>

## DAIHATSU

Make & Model	Eng Size	Type	Eng Model	Year	Part No.
--------------	----------	------	-----------	------	----------

### Move

L601	847cc		ED	1/1997 - 11/99	<b>PWP3059</b>
------	-------	--	----	----------------	----------------

### Pyzar

G303, 313	1.6, 1.6L		HD, HE	2/1997 on	<b>PWP3009</b>
-----------	-----------	--	--------	-----------	----------------

### Rocky

F80, 85, 87	2.0L		3Y	1984 - 89	<b>PWP894</b>
F80, 85, 87	2.2L		4Y	1990 - 94	<b>PWP894</b>
F70, 75, 77 Non Turbo	2.8L	Diesel	DG	1982 - 84	<b>PWP5028</b>
F70, 75, 77 Non Turbo	2.8L	Diesel	DL	1984 - 87	<b>PWP3110</b>
F70, 75, 77 Non Turbo	2.8L	Diesel	DL	1987 - 93	<b>PWP3111</b>
F70 Turbo	2.8L	Diesel	DL	1984 - 87	<b>PWP3008</b>
F70 Turbo	2.8L	Diesel	DL	1988 - 92	<b>PWP3108</b>

### Sirion

Hatch, GTVi	1.0L		EJDE	7/1998 on	<b>PWP7047</b>
	1.3L		K3-VE2	7/1998 on	<b>PWP8047</b>

### Terios

J100 4wd	1.3L		HCE	2/1997 on	<b>PWP7046</b>
----------	------	--	-----	-----------	----------------





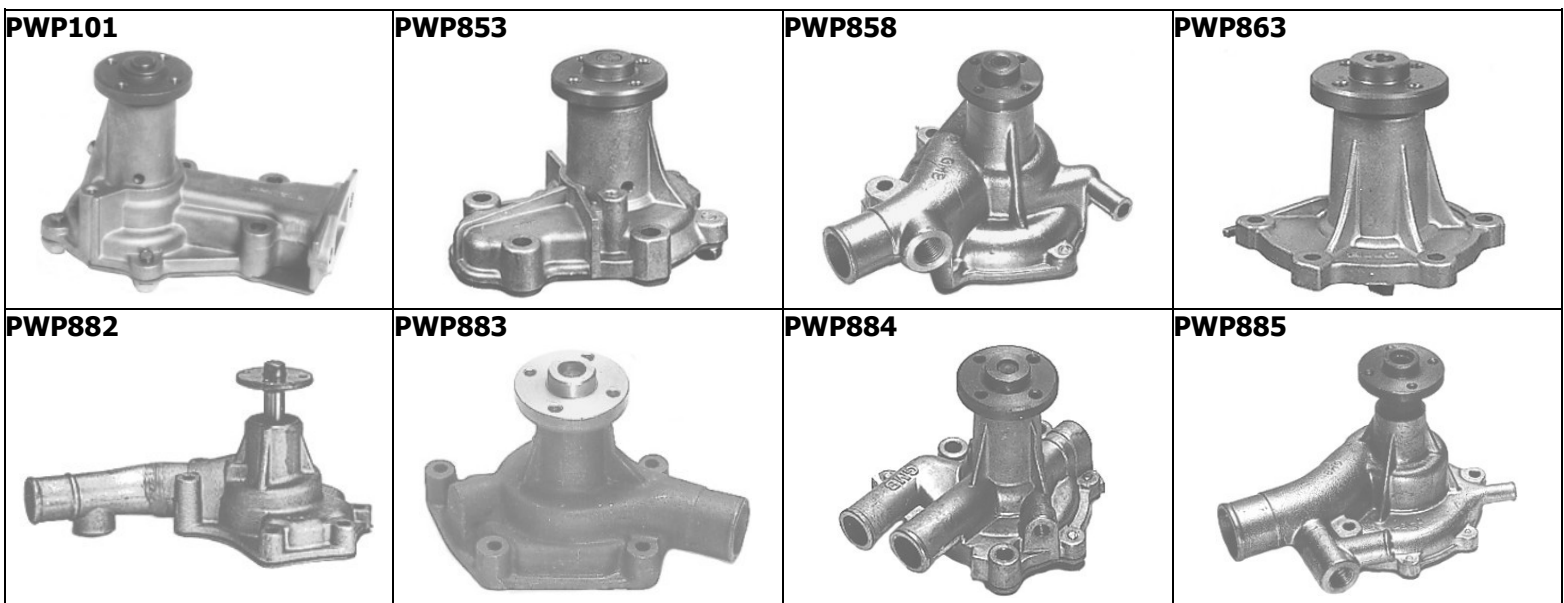









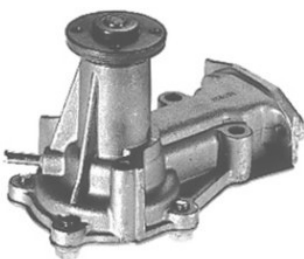



### YRV

YRV Wagon	1.3L		K3-VE2	7/1998 on	<b>PWP8047</b>
-----------	------	--	--------	-----------	----------------

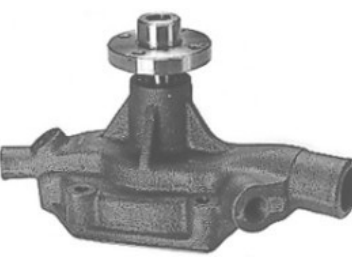

# PWP2008 WATER PUMP CATALOGUE

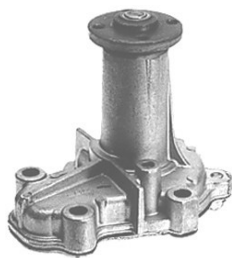
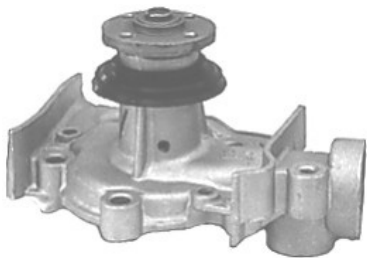
## DAIHATSU

Make & Model	Eng Size	Type	Eng Model	Year	Part No.
<b>PWP894</b> 	<b>PWP959</b> 	<b>PWP1070</b> 	<b>PWP2017</b> 		
<b>PWP2027</b> 	<b>PWP3008</b> 	<b>PWP3009</b> 	<b>PWP3038</b> 		
<b>PWP3059</b> 	<b>PWP3108</b> 	<b>PWP3110</b> 	<b>PWP3111</b> 		
<b>PWP3122</b> 	<b>PWP5028</b> 	<b>PWP7046</b> 	<b>PWP7047</b> 		
<b>PWP7145</b> <i>Photo Not Available</i>	<b>PWP8047</b> 	<b>PWP9026</b> 	<b>PWP9029</b> 		
<b>PWP9075</b> 					

## DODGE TRUCK

Make & Model	Eng Size	Type	Eng Model	Year	Part No.
<b>DODGE TRUCK</b>					
2.5 ton	273,318,383			1959 - 73	<b>PWP2919</b>
All	Slant 6			1960 - 70	<b>PWP578</b>
V8	318, 360			1973 on	<b>PWP806</b>



## EUNOS

Make & Model	Eng Size	Type	Eng Model	Year	Part No.
<b>30X</b>					
30XEC Coupe (Flat flange)	1.8L	V6	K8	1994 - 95	<b>PWP3075</b>
30XEC Coupe (Stepped flange)	1.8L	V6	K8	1994 - 95	<b>PWP3076</b>
<b>500</b>					
500CA	2.0L	V6	KF	11/92 - 12/98	<b>PWP3075</b>
500CA	2.0L	V6	KL	1992 - 12/98	<b>PWP3076</b>
<b>800</b>					
800M TA	2.5L	V6	KL	1994 - 95	<b>PWP3076</b>

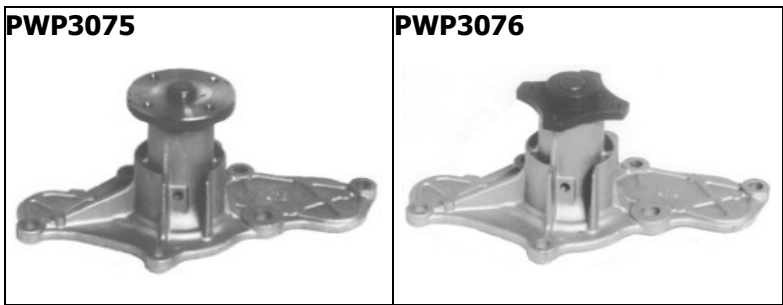



# PWP2008 WATER PUMP CATALOGUE

**FIAT**

Make & Model	Eng Size	Type	Eng Model	Year	Part No.
<b>124</b>					
124, Sedan & Wagon	1.2L			1966 - 71	<b>PWP571</b>
124, Series 2	1.6, 1.8L			1972 - 76	<b>PWP1017</b>
<b>127</b>					
127	900cc			1970 - 78	<b>PWP2111</b>
<b>128</b>					
128, Sedan & Coupe (Pump only)	1.3L			1971 - 78	<b>PWP866</b>
<b>131</b>					
131, Sedan & Wagon	1.6L			1976 - 81	<b>PWP867</b>
<b>132</b>					
132, Sedan	1.8, 2.0L			1975 - 81	<b>PWP1017</b>
132	1.8, 2.0L			1974 - 82	<b>PWP1017</b>
<b>1500</b>					
1500	1.5L			1960 - 68	<b>PWP580</b>
<b>Croma</b>					
Croma	2.0L	DOHC		1988 - 89	<b>PWP1431</b>
<b>Regatta</b>					
Regatta 100S	1.5L			1985 - 89	<b>PWP1428</b>
Regatta 100S	1.6L	DOHC		10/1985 - 87	<b>PWP2615</b>
<b>X1/9</b>					
X1/9 Coupe (Pump only)	1.5L			1978 - 83	<b>PWP866</b>



## FIAT

Make & Model	Eng Size	Type	Eng Model	Year	Part No.
--------------	----------	------	-----------	------	----------

### PWP2615

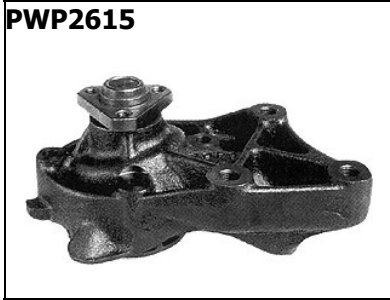

## FORD

Make & Model	Eng Size	Type	Eng Model	Year	Part No.
--------------	----------	------	-----------	------	----------

### Anglia

Anglia 105E	1.2L			1959 - 64	<b>PWP181</b>
-------------	------	--	--	-----------	---------------

### Capri

Mk I	1.6L			1968 - 70	<b>PWP181</b>
Mk I	1.6L			1970 - 73	<b>PWP730</b>
SA, SB	1.6L	SOHC	B6	1989 - 93	<b>PWP3230</b>
SA, SB, SC, SE Inc. Turbo	1.6L	DOHC	B6	1989 - 93	<b>PWP3010</b>
Capri 3000 GT	3.0L	V6		1969 - 81	<b>PWP932</b>

### Corsair

UA	2.0 L		CA20	1988 - 90	<b>PWP889</b>
	2.4 L		KA24E	1988 - 92	<b>PWP3022</b>

### Cortina

1200, 1300, 1500, 1600	1.2L—1.6L	4Cyl		1962 - 71	<b>PWP181</b>
TC	1.6L			1971 - 80	<b>PWP730</b>
TC, TD, TE, TF	2.0L	OHC		1971 - 80	<b>PWP746</b>
TC, TD (Non X-flow)	200, 250			1972 - 76	<b>PWP800</b>
TD, TE (X-flow, w/o air con)	3.3, 4.1L			1976 - 80	<b>PWP805</b>
TF (Alloy head)	3.3, 4.1L			1980 - 82	<b>PWP804</b>

### Cougar

SW	2.5L	DOHC V6	LC, BC	9/1999 on	<b>PWP7048</b>
----	------	---------	--------	-----------	----------------

# PWP2008 WATER PUMP CATALOGUE

**FORD**

Make & Model	Eng Size	Type	Eng Model	Year	Part No.
<b>Courier</b>					
SGC	1.8L		VC	1979 - 82	<b>PWP824</b>
SGCC	2.0L		MA	1982 - 84	<b>PWP756</b>
SGHE	2.0L	22mm round tooth belt	FE	1985 - 88	<b>PWP893</b>
	2.0L	19mm square tooth belt	FE	1985 - 88	<b>PWP895</b>
	2.0, 2.2L		FE, F2	1987 - 95	<b>PWP2032</b>
SGHG	2.6L		4G54	1987 - 90	<b>PWP838</b>
	2.6L		G6	1991 on	<b>PWP3123</b>
SGCD	2.2L	OHV Diesel	S2	1981 - 84	<b>PWP1028</b>
SGHW	2.2L	OHC Diesel	R2	1985 - 95	<b>PWP1018</b>
SGH3	2.5L	OHC Diesel	WL	9/96 - 12/98	<b>PWP3205</b>

<b>D Series</b>					
240, 254, 330, 360, 380	6Cyl	Diesel		1965 - 80	<b>PWP552</b>

<b>Econovan</b>					
SGMB	1.6L		NA	1979 - 84	<b>PWP824</b>
SGMR	1.4L		UB	1980 - 82	<b>PWP902</b>
SGME	1.8, 2.0L	22mm round tooth belt	FE	1981 - 89	<b>PWP893</b>
SGMD	1.8, 2.0L	19mm square tooth belt	FE	1981 - 86	<b>PWP895</b>
SGME, SGMD	1.8, 2.0L		FE	1/87 - 1/97	<b>PWP2032</b>
	2.0L		FE	2/1997 on	<b>PWP2032</b>
SGMD	2.2L	OHV Diesel	S2	1981 - 84	<b>PWP1028</b>
SGMW	2.2L	OHC Diesel	R2	1984 - 95	<b>PWP1018</b>
JH	2.5L	OHC Diesel	WL	10/1999 on	<b>PWP3205</b>

<b>Escape</b>					
BA, ZA, ZB	3.0L	V6	AJ	02/2001 on	<b>PWP7048</b>
BA, ZA, ZB	2.3L	DOHC	L3	02/2001 on	<b>PWP4075</b>

<b>Escort</b>					
Mk1	1.1, 1.3L			1968 - 70	<b>PWP181</b>
Mk2	4Cyl	1.1, 1.3, 1.6L		1971 - 80	<b>PWP730</b>
	2.0 L			1978 - 80	<b>PWP746</b>
Mk5	1.6L	DOHC		1992 - 96	<b>PWP999</b>
Van	1.3L			1971 - 78	<b>PWP181</b>
	1.3, 1.6L			1971 - 81	<b>PWP730</b>
	2.0L			1978 - 81	<b>PWP746</b>

## FORD

Make & Model	Eng Size	Type	Eng Model	Year	Part No.
--------------	----------	------	-----------	------	----------

### Explorer

UN, UP, UQ, US	4.0L	OHV V6	VZA	10/96 - 09/01	<b>PWP6001</b>
UN, UP, UQ, US	4.0L	SOHC V6	XZA	1996 on	<b>PWP2009</b>
UT, UX, UZ	4.6L	V8	ZZA	01/2000 on	<b>PWP7099</b>

### F Series

F100, F250, F350 (With 2.5" diameter hub)	240, 300 cid	6 Cyl		1965 - 74	<b>PWP810</b>
F100, F250, F350	4.1L	6 Cyl		1974 - 78	<b>PWP800</b>
F100, F250, F350 (Without air con)	4.1L	6 Cyl		1978 - 81	<b>PWP805</b>
F100, F250, F350 (With air con)	4.1L	6 Cyl		1981 - 87	<b>PWP804</b>
V8 Big Block	429, 460	6 Cyl		1974 - 76	<b>PWP486</b>
F100, F250, F350, F600	302, 351	Cleveland	<b># NOTE:</b>	1974 - 85	<b>PWP809</b>
F100	5.0L	Windsor, EFi		1985 - 87	<b>PWP2953</b>
F150	302, 351	Windsor, EFi		1987 - 92	<b>PWP2631</b>
F100, F250, Bronco	302, 351	Windsor, EFi		1989 on	<b>PWP2631</b>
F250	7.3L	Diesel Turbo		08/01 on	<b>PWP7150</b>

**# NOTE:** Use Cast Iron not Aluminium (**PWP809CAST**)

### Fairlane

ZA, ZB, ZC	200, 221 cid	6 Cyl		1966 - 70	<b>PWP564</b>
ZD, ZF, ZG (Non X-flow)	3.3, 4.1L	6 Cyl		1970 - 75	<b>PWP800</b>
ZG (Without air con)	3.3, 4.1L	6 Cyl		1973 - 76	<b>PWP805</b>
ZH, ZJ (Without air con)	3.3, 4.1L	6 Cyl		1976 - 80	<b>PWP805</b>
ZH (With air con)	4.1L	6 Cyl		1976 - 80	<b>PWP804</b>
NA (With 5 blade fan)	3.9L	6 Cyl		6/88 - 3/95	<b>PWP1040</b>
NA, NB, NC (With 10 blade fan)	3.9L	6 Cyl		6/88 - 3/95	<b>PWP1040</b>
NF, NL	4.0L	6 Cyl (WP) With Pulley		3/95 - 1/99	<b>PWP3079</b> <b>PWP3079WP</b>
AU Series 1	4.0L	6 Cyl (WP) With Pulley		2/99 - 4/00	<b>PWP3079</b> <b>PWP3079WP</b>
AU Series 2	4.0L	6 Cyl (WP) With Pulley		5/00 - 10/02	<b>PWP3079</b> <b>PWP3079WP</b>
BA	4.0L	6Cyl DOHC (WP) With Pulley		11/2002 on	<b>PWP2079</b>
ZA, ZB, ZC Early, XW, ZC Windsor	302, 351	V8		1966 - 70	<b>PWP807</b>
ZC, ZD. Windsor	351	V8		1970 - 71	<b>PWP2953</b>
ZC, ZD Cleveland	302, 351	V8	<b># NOTE:</b>	1970 - 71	<b>PWP809</b>
ZF, ZG, ZH, ZJ, ZK Cleveland	302, 351	V8	<b># NOTE:</b>	1971 - 85	<b>PWP809</b>
NC, NF, NL Windsor	4.9L	EFI		1991 - 1/99	<b>PWP2630</b>
AU Series 1 & 2	5.0L	V8		2/1999 on	<b>PWP4002</b>
BA	5.4L	V8		09/2002 on	<b>PWP8002</b>

# PWP2008 WATER PUMP CATALOGUE

**FORD**

Make & Model	Eng Size	Type	Eng Model	Year	Part No.
<b>Falcon</b>					
XK, XL, XM, XP, XR, XT, XW	170			1960 - 68	<b>PWP564</b>
XY, XA, XB (Non X-flow)	200, 250			1970 - 76	<b>PWP800</b>
XB ( Non X-flow with air con)	200, 250			1973 - 76	<b>PWP805</b>
XC, XD (X-flow without air con)	200, 250			1976 - 80	<b>PWP805</b>
XC, XD, XE, XF (With air con)	3.3, 4.1L			1982 - 88	<b>PWP804</b>
EA (With 5 blade fan)	3.9L			3/88 - 11/89	<b>PWP1040</b>
EA, EB, ED (With 10 blade fan)	3.9, 4.0L			1989 - 95	<b>PWP1040</b>
EG Ute & Panel Van (With 10 blade fan)	4.0L			1994 - 95	<b>PWP1040</b>
EF, EL, AU Series I & II	4.0L	6 Cyl (WP) With Pulley		8/94 - 10/02	<b>PWP3079</b> <b>PWP3079WP</b>
XG, XH Ute & Panel Van	4.0L	6 Cyl (WP) With Pulley		8/94 - 10/03	<b>PWP3079</b> <b>PWP3079WP</b>
BA	4.0L	6 Cyl DOHC (WP) With Pulley		11/2002 on	<b>PWP2079</b> <b>PWP2079WP</b>
XR, XT, early XW Windsor	302, 351	V8		1966 - 70	<b>PWP807</b>
XW, XY Windsor	302, 351	V8		1970 - 71	<b>PWP2953</b>
XW, XY Cleveland	351	V8	<b># NOTE:</b>	1970 - 71	<b>PWP809</b>
XA, XB, XC, XD, XE Cleveland	302, 351	V8	<b># NOTE:</b>	1971 - 85	<b>PWP809</b>
V8 Big block eng.	429, 460	V8		1974 - 76	<b>PWP486</b>
EB, ED, EF Windsor	4.9L	EFI		1991 - 09/98	<b>PWP2630</b>
AU	5.0L	EFI		2/98 - 09/02	<b>PWP4002</b>
BA	5.4L	V8		10/2002 on	<b>PWP8002</b>

**# NOTE:** Available in Cast Iron (**PWP809CAST**)

<b>Festiva</b>					
WA	1.3L			1991 - 93	<b>PWP3230</b>
WB	1.3L			1994 on	<b>PWP3230</b>

<b>Focus</b>					
1.8, 2.0i 16V	2.0L	DOHC	SD	11/2002 on	<b>PWP7043</b>

<b>KA</b>					
TA, TB	1.3L		XJ	10/1999 on	<b>PWP7049</b>

<b>Laser</b>					
KA, KB	1.3, 1.5L		E3, E5	3/81 - 85	<b>PWP852</b>
KC, KE, KF	1.3, 1.6L	SOHC	B3, B6	10/85 - 90	<b>PWP3230</b>
KF		1.3, 1.6, 1.8L	B3, B6, BP	1985 - 88	<b>PWP3230</b>
KF, KH	1.6, 1.8L	EFI, DOHC	B6, BP	3/90 - 2/94	<b>PWP3010</b>
KJ, KL	1.6, 1.8L	DOHC	B6, BP	3/94 - 2/99	<b>PWP3081</b>

## FORD

Make & Model	Eng Size	Type	Eng Model	Year	Part No.
--------------	----------	------	-----------	------	----------

### Laser Continued..

TX3	1.6, 1.8L	DOHC	B6, BP	1988-90	<b>PWP3010</b>
KN, KQ	1.8, 2.0L	DOHC	FP, ZM	2/99 - 09/02	<b>PWP3081</b>

### LTD

FC (Without air con)	250			10/79 - 88	<b>PWP805</b>
FC, FD, FE (With air con)	250			1980 - 88	<b>PWP804</b>
DA, DB, DC	3.9 & 4.0L			1988 - 95	<b>PWP1040</b>
DF, DL, AU Series I & II	4.0L	6 Cyl (WP) With Pulley		1995 on	<b>PWP3079</b> <b>PWP3079WP</b>
Landau	351	Windsor		1970 - 73	<b>PWP807</b>
FC, FD	302, 351	Cleveland	<b># NOTE:</b>	1973 - 84	<b>PWP809</b>
DC, DF, DL	4.9L	Windsor		1991 - 09/98	<b>PWP2630</b>
AU Series 1 & 2	5.0L	16 OHV		02/98 - 09/02	<b>PWP4002</b>

**# NOTE:** Available in Cast Iron (**PWP809CAST**)

### Maverick

KY	4.2L		TB42	1988 on	<b>PWP6027</b>
GY	4.2L	Diesel	TD42	1988 - 93	<b>PWP6056</b>

### Meteor

GA, GB	1.3, 1.5L		E3, E5	4/1982 - 85	<b>PWP852</b>
GC	1.6L		B6	10/1985 - 87	<b>PWP3230</b>

### Mondeo

HA, HB, HC, HD	2.0L	DOHC	ZH20	7/95 - 12/99	<b>PWP2990</b>
HE	2.0L	DOHC	SD	5/98 - 10/00	<b>PWP7043</b>
	2.5L	DOHC V6	KL	2/00 - 10/00	<b>PWP7048</b>

### Prefect

107E				1959 - 62	<b>PWP181</b>
------	--	--	--	-----------	---------------

### Probe

ST, SU (Flat flange)	2.5L	V6		9/1994 on	<b>PWP3075</b>
ST, SU (Stepped flange)	2.5L	V6		9/1994 on	<b>PWP3076</b>

### Raider

4WD	2.6L		G6	8/91 - 10/96	<b>PWP3123</b>
-----	------	--	----	--------------	----------------

### Spectron

SGME	1.6L		NA	1979 - 84	<b>PWP824</b>
	1.8, 2.0L	22mm round tooth belt	FE	1984 - 86	<b>PWP893</b>
	1.8, 2.0L	19mm square tooth belt	FE	1984 - 86	<b>PWP895</b>
	1.8, 2.0L		FE	1987 on	<b>PWP2032</b>

# PWP2008 WATER PUMP CATALOGUE

**FORD**

**Make & Model**

**Eng Size**

**Type**

**Eng Model**

**Year**

**Part No.**

**Taurus**

DN, DP	3.0L	V6	AX4N	3/96 - 9/98	<b>PWP3135</b>
--------	------	----	------	-------------	----------------

**Telstar**

AR, AS TX5	2.0L	19mm square tooth belt	FE	5/83 - 87	<b>PWP895</b>
AR, AS TX5	2.0L	22mm round tooth belt	FE	5/83 - 87	<b>PWP893</b>
AT, AV	2.2L		FE, F2	1987 on	<b>PWP2032</b>
AX, AY	2.0L		FS	1992 - 97	<b>PWP3082</b>
AX (Flat flange)	2.5L	V6	KL	1/92 - 97	<b>PWP3075</b>
AX (Stepped flange)	2.5L	V6	KL	1/92 - 97	<b>PWP3076</b>

**Trader**

0409, 0509	3.0L	Diesel	HA	1979 - 84	<b>PWP1150</b>
0409	2.0L		V	1979 - 81	<b>PWP2014</b>
0409, 0509	3.0L	Diesel	HA	1981 - 84	<b>PWP1150</b>
	4.1L	Diesel	ZB	1981 - 91	<b>PWP3014</b>
0409, 0509, 0812 Inc. Turbo	3.5L	Diesel	SL	1984 - 97	<b>PWP3013</b>





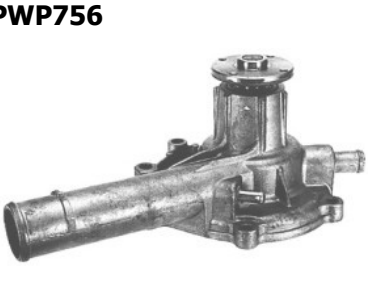
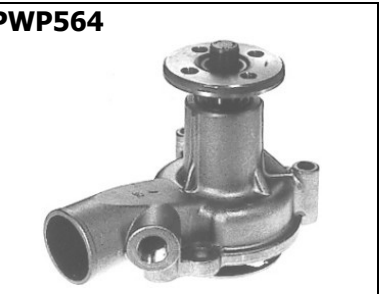
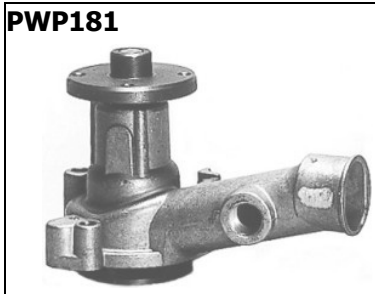





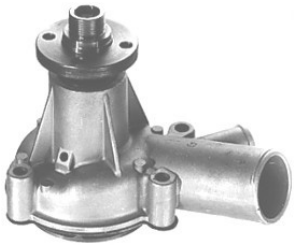
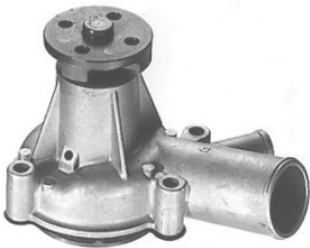

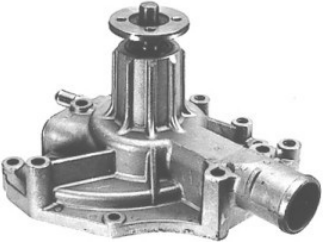

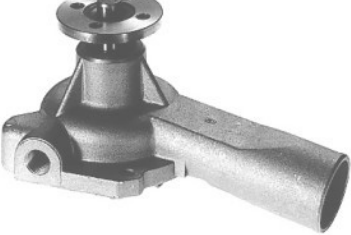
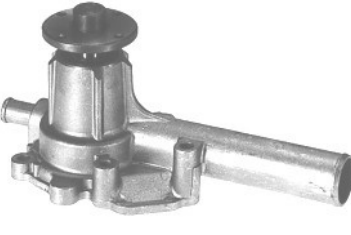
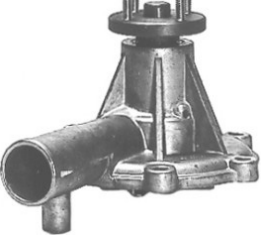
**Transit**

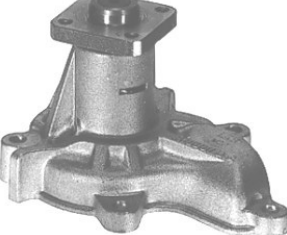
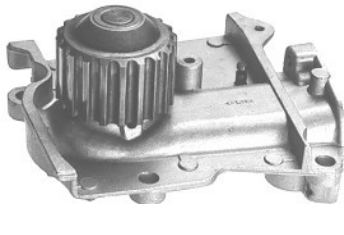
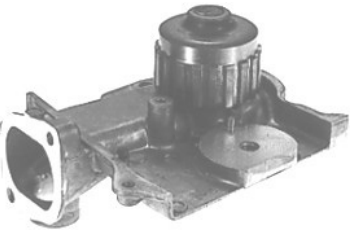
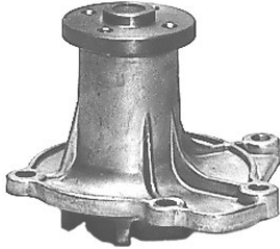
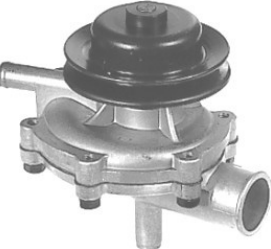
Van	2.0L	V4		1965 - 74	<b>PWP932</b>
Van	1.7L			1966 - 75	<b>PWP932</b>
VF, VG	2.0L		4G	5/96 - 10/00	<b>PWP7021</b>
VE, VF, VG	2.5L	Diesel	4D, 4E	4/94 - 10/00	<b>PWP7030</b>
VH, VJ	2.3L	DOHC	N7A	10/2000 on	<b>PWP7200</b>
	2.4L	Diesel		2003 on	<b>PWP8050</b>
All Models	250			1973 - 78	<b>PWP800</b>
	4.1L			1978 - 81	<b>PWP805</b>

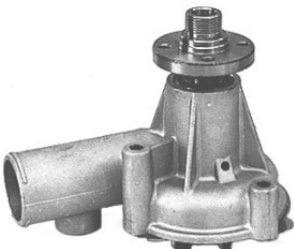

**FORD**



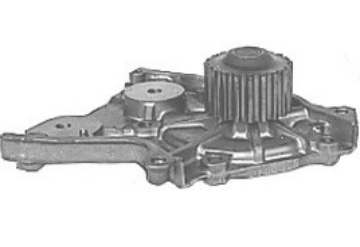
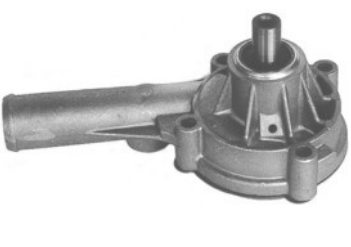







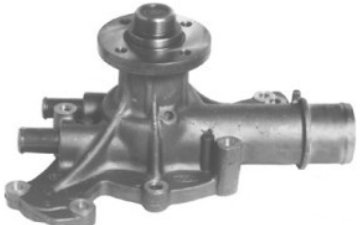
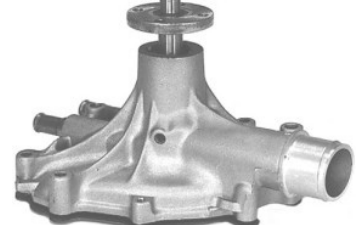
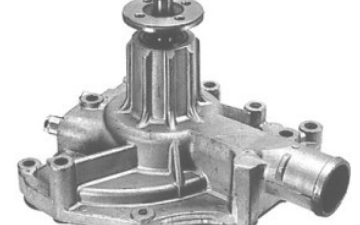

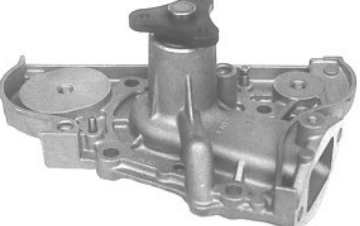



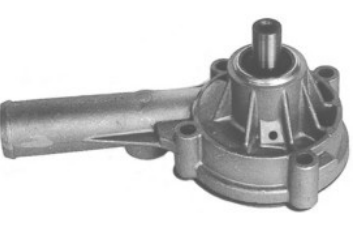

Make & Model	Eng Size	Type	Eng Model	Year	Part No.
--------------	----------	------	-----------	------	----------

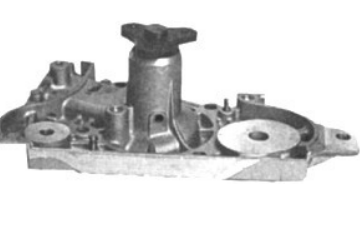
<b>PWP804</b> 	<b>PWP805</b> 	<b>PWP807</b> 	<b>PWP809</b> 
<b>PWP809CAST</b> 	<b>PWP810</b> 	<b>PWP824</b> 	<b>PWP838</b> 
<b>PWP852</b> 	<b>PWP889</b> 	<b>PWP893</b> 	<b>PWP895</b> 
<b>PWP902</b> 	<b>PWP932</b> 	<b>PWP990</b> 	<b>PWP999</b> 
<b>PWP1018</b> 	<b>PWP1028</b> 	<b>PWP1040</b> 	<b>PWP1150</b> 
<b>PWP2009</b> 	<b>PWP2014</b> 	<b>PWP2032</b> 	<b>PWP2079</b> 



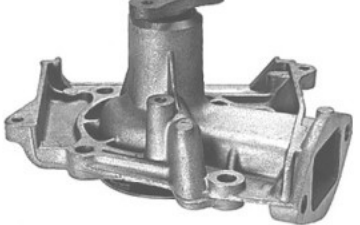

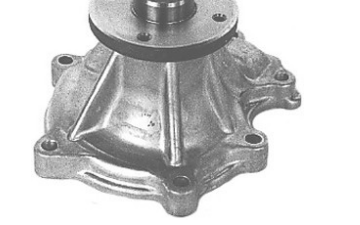





# PWP2008 WATER PUMP CATALOGUE

**FORD**

Make & Model	Eng Size	Type	Eng Model	Year	Part No.
<b>PWP2079WP</b>	<b>PWP2630</b>	<b>PWP2631</b>	<b>PWP2953</b>		
					
<b>PWP2990</b>	<b>PWP3010</b>	<b>PWP3013</b>	<b>PWP3014</b>		
					
<b>PWP3022</b>	<b>PWP3075</b>	<b>PWP3076</b>	<b>PWP3079</b>		
					
<b>PWP3079WP</b>	<b>PWP3081</b>	<b>PWP3082</b>	<b>PWP3123</b>		
					
<b>PWP3135</b>	<b>PWP3205</b>	<b>PWP3230</b>	<b>PWP4002</b>		
					
<b>PWP6001</b>	<b>PWP6027</b>	<b>PWP6056</b>	<b>PWP7021</b>		
					

**FORD**

Make & Model	Eng Size	Type	Eng Model	Year	Part No.
<b>PWP7030</b> 	<b>PWP7043</b> 	<b>PWP7048</b> 	<b>PWP7049</b> 		
<b>PWP7099</b> 	<b>PWP7150</b> 	<b>PWP7200</b> 	<b>PWP8002</b> 		
<b>PWP8050</b> 					

**FORKLIFT**

Make & Model	Eng Size	Type	Eng Model	Year	Part No.
<b>Forklift</b>					
Astron	2.6L				<b>PWP1026</b>
Komatsu, Nissan, TCM			H20		<b>PWP1260</b>
Saturn	1.6L				<b>PWP1014</b>

<b>PWP1014</b> 	<b>PWP1026</b> 	<b>PWP1260</b> 
------------------------------------------------------------------------------------------------------	-------------------------------------------------------------------------------------------------------	--------------------------------------------------------------------------------------------------------

# PWP2008 WATER PUMP CATALOGUE

**GM**

Make & Model	Eng Size	Type	Eng Model	Year	Part No.
<b>Chevrolet</b>					
Chevrolet V6		2.8, 3.1, 3.4L		1987 - 96	<b>PWP9200</b>
<b>Cadillac</b>					
Cadillac V6		2.8, 3.1, 3.4L		1987 - 96	<b>PWP9200</b>
<b>Oldsmobile</b>					
Oldsmobile V6		2.8, 3.1, 3.4L		1987 - 96	<b>PWP9200</b>
<b>Pontiac</b>					
Pontiac V6		2.8, 3.1, 3.4L		1987 - 96	<b>PWP9200</b>



**HOLDEN**

Make & Model	Eng Size	Type	Eng Model	Year	Part No.
<b>Apollo</b>					
JK	2.0L		3S	1989 - 90	<b>PWP9067</b>
JK, JL, JM, JP	2.0L	<b>PUMP and HOUSING</b>	3SFE, 5SFE	1989 - 97	<b>PWP3047 PWP3047A</b>
JM	2.5, 3.0L	V6	3VZFE	93 - 97	<b>PWP3054</b>
<b>Astra</b>					
LB, LC	1.5, 1.6L		E15,E16	1984 - 87	<b>PWP888</b>
LD	1.6, 1.8L		16LF,18LF	1987 - 98	<b>PWP881</b>
TR (With shield)	1.6L	SOHC	C16	6/96 - 8/98	<b>PWP3074</b>
TR (Without shield)	1.6L	SOHC	C16	6/96 - 8/98	<b>PWP3071</b>
TR	1.8, 2.0L	DOHC	C18, X20	6/96 - 8/98	<b>PWP7220</b>
TS	1.8L	DOHC	X18	8/98 - 01/05	<b>PWP7050</b>
TS Inc. Turbo	2.0L	DOHC	Z20	8/98 - 01/05	<b>PWP7031</b>
TS	2.2L	DOHC	C22	8/98 - 01/05	<b>PWP7220</b>
AH	1.8L	DOHC	Z18XE	10/04 on	<b>PWP7050</b>

## HOLDEN

Make & Model	Eng Size	Type	Eng Model	Year	Part No.
<b>Barina</b>					
MB, ML (Auto transmission)	1.3L		G13A	1985 - 89	<b>PWP2013</b>
MB	1.0L		G10A	1984 - 88	<b>PWP2008</b>
MB,ML (Manual transmission)	1.3L		G13 A	1985 - 89	<b>PWP2008</b>
MF, MH	1.3L		G13B	1989 on	<b>PWP3037</b>
MF, MH	1.6L		G16A	1989 - 92	<b>PWP3036</b>
SB	1.2, 1.4L	SOHC	C12,C14	03/94 - 12/00	<b>PWP3071</b>
SB	1.6L	DOHC	X16XE	03/94 - 12/00	<b>PWP3072</b>
XC To Engine No. 20U75998	1.4L	DOHC	X14XE	03/01 - 11/05	<b>PWP3072</b>
XC From Engine No. 20U75999	1.4L	DOHC	X14XE	03/01 - 11/05	<b>PWP4072</b>
XC	1.4L	DOHC	X14XEP	03/01 - 11/05	<b>PWP5072</b>
XC	1.8L	DOHC	X18XE	03/01 - 11/05	<b>PWP7050</b>

## Calibra

YE	2.0L	SOHC	C20N	1992 on	<b>PWP9076</b>
YE (With shield) Inc. Turbo	2.0L	DOHC	C20XE	1992 on	<b>PWP2800</b>
YE (Without shield) Inc. Turbo	2.0L	SOHC	C20LET	1992 on	<b>PWP7031</b>
YE	2.0L	SOHC	C20NE	1992 on	<b>PWP7023</b>
YE	2.5L	V6	C25N	7/95 - 10/97	<b>PWP7022</b>

## Camira

JB, JD	1.6L		16J	1982 - 86	<b>PWP881</b>
JD	1.8L		18J	1984 - 87	<b>PWP881</b>
JE	2.0L		20J	1987 on	<b>PWP9076</b>

## Combo

SB	1.4L		C14NZ	03/94 - 12/00	<b>PWP3071</b>
SB	1.6L			01/96 - 12/00	<b>PWP3072</b>
XC	1.8L	DOHC	X18XE	03/01 on	<b>PWP7050</b>

## Commodore

VC	1.9L		Starfire	1980 - 81	<b>PWP814</b>
VH	1.9L		Starfire	1981 - 83	<b>PWP879</b>
VB, VC	2.8, 3.3L			1978 - 81	<b>PWP814</b>
VH, VK	2.8, 3.3L			1981 - 86	<b>PWP879</b>
VL	3.0L		RB30E	1986 - 88	<b>PWP898</b>
VN	3.8L	V6	<b>#NOTE 1:</b>	1988 - 91	<b>PWP4000A</b>
VP, VR	3.8L	V6	<b>#NOTE 1:</b>	1991 - 94	<b>PWP4000A</b>

**#NOTE 1: Part No. PWP1039, 3000, 4000 & 4001 can be replaced with ONE water pump. Number PWP4000A**

# PWP2008 WATER PUMP CATALOGUE

## HOLDEN

Make & Model	Eng Size	Type	Eng Model	Year	Part No.
--------------	----------	------	-----------	------	----------

### Commodore Continued..

VS to VIN.VH515478	3.8L	V6	<b>#NOTE 1:</b>	1995 on	<b>PWP4000A</b>
VS from VIN.VH515479 Series 2	3.8L	V6	<b>#NOTE 1:</b>	6/96 - 97	<b>PWP4000A</b>
VT, VX, VY (Inc. Supercharger)	3.8L	V6	<b>#NOTE 1:</b>	6/96 - 10/04	<b>PWP4000A</b>
VZ	3.8L	DOHC V6	SFI	10/04 on	<b>PWP5000</b>
VB, VC, VH	4.2, 5.0L		<b>#NOTE 2:</b>	1978 - 81	<b>PWP808/ 803</b>
VH, VK, VL, VN, VP, VR, VS, VT Series 1	4.2, 5.0L		<b>#NOTE 2:</b>	1984 - 7/99	<b>PWP1000</b>
VR, VS, VT Series 2, VX-VU (Inc HSV)	5.7L	V8 16 OHV		08/99 - 09/02	<b>PWP9074</b>
VY, WK	5.7L	V8 16 OHV		10/02 - 05/04	<b>PWP9074</b>
VZ, WL	5.7L, 6.0L	V8 16 OHV		06/04 - 07/06	<b>PWP9074</b>

**#NOTE 1: Part No. PWP1039, 3000, 4000 & 4001 can be replaced with ONE water pump. Number PWP4000A**

**#NOTE 2: PART No. PWP808/803 AND PWP1000 DO NOT INTERCHANGE.  
2. THE REMOVAL OF THE FAN CLUTCH ASSY. WILL VOID ANY WARRANTY.  
3. PWP808/803 HAS ROUNDED TOP BLADE.  
4. PWP1000 HAS SQUARE TOP BLADE.**

### Cruze

YG	1.5L	16V DOHC	M15A	06/02 on	<b>PWP5012</b>
----	------	----------	------	----------	----------------

### Drover

QB	1.3L		G13A	1985 - 87	<b>PWP2008</b>
----	------	--	------	-----------	----------------

### Frontera

MB25	2.0L		X20SE	10/95 on	<b>PWP7023</b>
MX	2.2L		X22SE	2/1999 on	<b>PWP7220</b>
MX	3.2L	V6	6VD1	2/1999 on	<b>PWP3112</b>

### Gemini

TE,TF,TG	1.8L	Diesel	4FB1	1981 - 84	<b>PWP5014</b>
TX, TC, TD, TE, TF, TG	1.6L		G161Z	1976 - 85	<b>PWP827</b>
RB	1.5L		4XC1	1985 - 87	<b>PWP5019</b>

### Holden

FX, FJ, EK, FB, FC, FE, EJ	(Grey Motor)			1948 - 63	<b>PWP220</b>
EH, HD, HR, HK	(Red Motor)	149, 161, 179, 186		1964 - 69	<b>PWP587</b>
HT, HG, HQ, HJ	(Red Motor)	161, 173, 186, 202		1969 - 76	<b>PWP726</b>
HJ, HX, HZ (Without air con)	202			1974 - 80	<b>PWP814</b>
WB	202			1980 - 85	<b>PWP879</b>
HK, HT	307, 327			1968 - 69	<b>PWP2593</b>
HG, HQ, HJ, HX	350			1970 - 78	<b>PWP812</b>

## HOLDEN

Make & Model	Eng Size	Type	Eng Model	Year	Part No.
--------------	----------	------	-----------	------	----------

### Holden Continued..

HT, HG, HQ, HJ, HX, HZ, WB	4.2, 5.0L		<b>#NOTE:</b>	1969 - 82	<b>PWP808/803</b>
WB	4.2, 5.0L		<b>#NOTE:</b>	1982 - 85	<b>PWP1000</b>

**#NOTE: PART No. PWP808/803 AND PWP1000 DO NOT INTERCHANGE.  
2. THE REMOVAL OF THE FAN CLUTCH ASSY. WILL VOID ANY WARRANTY.  
3. PWP808/803 HAS ROUNDED TOP BLADE.  
4. PWP1000 HAS SQUARE TOP BLADE.**

### Jackaroo

UBS	1.9L		G200Z	1981 - 85	<b>PWP827</b>
UBS52, 53	2.2L	Diesel	C223	1983 - 88	<b>PWP5013</b>
UBS25, 55	2.8L	Diesel	4JB1	1988 - 92	<b>PWP1100</b>
UBS16	2.3L		4ZD1	1985 - 88	<b>PWP1022</b>
UBS17	2.6L		4ZE1	1988 - 90	<b>PWP6380</b>
UBS25	3.1L	Diesel	4JG2	05/92 - 12/97	<b>PWP3113</b>
UBS25	3.2L	V6	6VD1	05/92 - 12/97	<b>PWP3112</b>
L8 UBS26	3.5L	V6	6VE1	02/98 - 12/03	<b>PWP7040</b>
L8 UBS26	3.0L	Diesel	4JX1	02/98 - 12/03	<b>PWP1111</b>

### Luv

KB20	1.6L		G161	1967 - 76	<b>PWP1001</b>
KB20	1.6L		G161	1976 - 81	<b>PWP827</b>

### Monaro

V2 CV6	3.8L	V6		12/01 - 08/03	<b>PWP4000A</b>
V2 CV8	5.7L	V8 16 OHV		12/01 - 09/06	<b>PWP9074</b>

### Nova

LE, LF	1.4, 1.6L		4AFC, 6AF	1989 on	<b>PWP3039</b>
LG	1.6L		4AFE	10/94 - 97	<b>PWP3084</b>
LF, LG	1.8L		7AFE	9/91 - 97	<b>PWP3083</b>

### Piazza

Turbo	2.0L		4ZC1	4/86 - 87	<b>PWP3073</b>
-------	------	--	------	-----------	----------------

### Rodeo

KBD	2.0L	Diesel	C190	1980 - 81	<b>PWP864</b>
KBD	2.2L	Diesel	C223	1983 - 85	<b>PWP5013</b>
TFS	2.5L	Diesel	4JA1	1988 - 93	<b>PWP1100</b>
TFS, G3, G6, R7	2.8L	Diesel	4JB1	03/93 - 02/03	<b>PWP1100</b>
KB	1.6L		G161	1981 - 83	<b>PWP827</b>

# PWP2008 WATER PUMP CATALOGUE

## HOLDEN

Make & Model

Eng Size

Type

Eng Model

Year

Part No.

### Rodeo Continued..

KB	2.0L		G200	1983 - 85	<b>PWP827</b>
KB	2.3L		4ZD1	1985 - 91	<b>PWP1022</b>
TFR	2.6L		4ZE1	88 - 6/98	<b>PWP6380</b>
TFR	3.2L	V6	6VD1	1995 - 7/98	<b>PWP3112</b>
TFR	3.2L	V6	6VD1	8/1998 on	<b>PWP7040</b>
R7	2.2L		C22NE	1999 on	<b>PWP7222</b>
RA	3.0L	Turbo Diesel	4XJ1	02/1997 on	<b>PWP8005</b>
RA	3.5L	V6	6VE1	03/2003 on	<b>PWP7040</b>

### Scurry

NB	1.0L		F10A	1985 - 87	<b>PWP2013</b>
----	------	--	------	-----------	----------------

### Shuttle

WFR11	1.8L		4ZB1	1982 - 87	<b>PWP5023</b>
WFR11	1.9L		4ZC1	1987 - 90	<b>PWP3048</b>
WFR51	2.0L	Diesel	4FC1	1982 - 86	<b>PWP5020</b>

### Suburban

1500 Series 4x4	5.7L	V8	L31	2/98 - 1/00	<b>PWP9078</b>
2500 Series 4x4	6.5L	V8 Turbo Diesel		2/96 - 1/99	<b>PWP9081</b>
2500 Series 4x4	6.5L	V8 Turbo Diesel		2/96 - 1/00	<b>PWP9082</b>

### Sunbird

LX, UC	1.9L		Opel	1977 - 78	<b>PWP555</b>
UC	1.9L		Starfire	1978 - 80	<b>PWP814</b>

### Torana

HB, LC, LJ, TA	1.2, 1.3L			1967 - 75	<b>PWP786</b>
LC, LJ	1.6L			1969 - 73	<b>PWP591</b>
LH, LX	1.9L			1974 - 76	<b>PWP555</b>
LC, LJ, LH, LX		161, 173, 186		1969 - 77	<b>PWP726</b>
LX, UC	173, 202			1977 - 79	<b>PWP814</b>
LH, LX	4.2, 5.0L		<b>#NOTE:</b>	1974 - 78	<b>PWP808/ 803</b>

**#NOTE: PART No. PWP808/803 AND PWP1000 DO NOT INTERCHANGE.  
2. THE REMOVAL OF THE FAN CLUTCH ASSY. WILL VOID ANY WARRANTY.  
3. PWP808/803 HAS ROUNDED TOP BLADE.  
4. PWP1000 HAS SQUARE TOP BLADE.**

### Vectra

JR, JS	2.0, 2.2L	DOHC	C20SE, 22SE	6/97 - 10/00	<b>PWP7220</b>
JR, JS Series 2	2.5L		X25	6/1997 on	<b>PWP7022</b>

## HOLDEN

Make & Model	Eng Size	Type	Eng Model	Year	Part No.
--------------	----------	------	-----------	------	----------

### Vectra Continued..









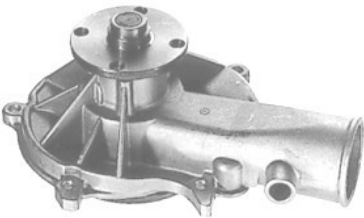
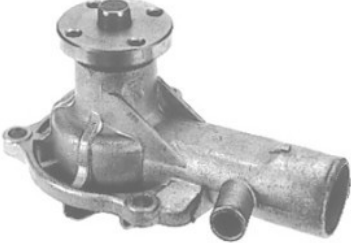

JS	2.0L	SOHC	C20NE	8/98 - 10/00	<b>PWP7023</b>
JS	2.6L	DOHC	Y26	10/00 - 03/03	<b>PWP7022</b>
ZC	2.2L	DOHC	Z22SE	03/2003 on	<b>PWP8222</b>

### Viva

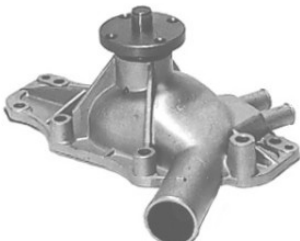
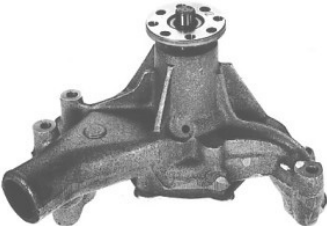
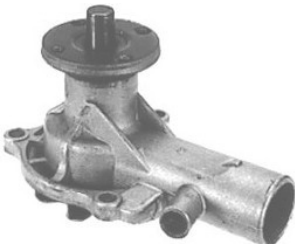
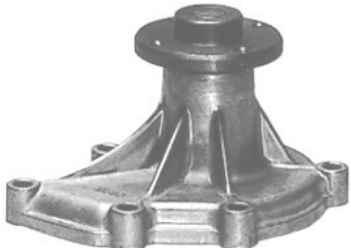
HA, HB	1.3L			1964 - 67	<b>PWP786</b>
--------	------	--	--	-----------	---------------

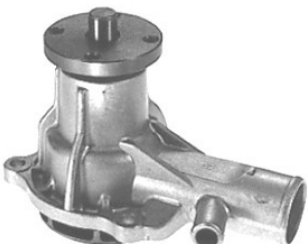
### Zafira

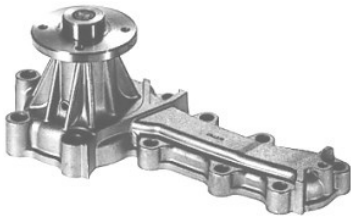
Zafira	2.2L	DOHC	Z22SE	6/2001 on	<b>PWP8222</b>
--------	------	------	-------	-----------	----------------

<b>PWP220</b> 	<b>PWP555</b> 	<b>PWP587</b> 	<b>PWP591</b> 
<b>PWP726</b> 	<b>PWP786</b> 	<b>PWP808/803</b> 	<b>PWP812</b> 
<b>PWP814</b> 	<b>PWP827</b> 	<b>PWP864</b> 	<b>PWP879</b> 
<b>PWP881</b> 	<b>PWP888</b> 	<b>PWP898</b> 	<b>PWP1000</b> 













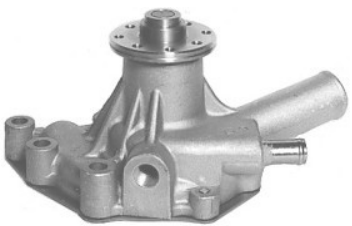

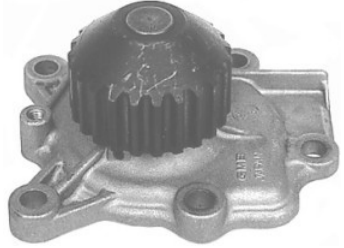
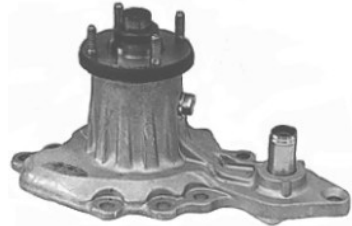







# PWP2008 WATER PUMP CATALOGUE

**HOLDEN**

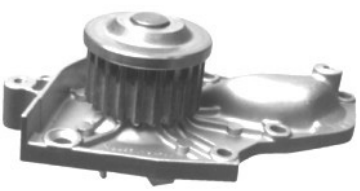
Make & Model	Eng Size	Type	Eng Model	Year	Part No.
<b>PWP1001</b>	<b>PWP1022</b>	<b>PWP1100</b>	<b>PWP1111</b>		
					
<b>PWP2008</b>	<b>PWP2013</b>	<b>PWP2593</b>	<b>PWP2800</b>		
					
<b>PWP3036</b>	<b>PWP3037</b>	<b>PWP3039</b>	<b>PWP3047</b>		
					
<b>PWP3047A</b>	<b>PWP3048</b>	<b>PWP3054</b>	<b>PWP3071</b>		
					
<b>PWP3072</b>	<b>PWP3073</b>	<b>PWP3074</b>	<b>PWP3083</b>		
					
<b>PWP3084</b>	<b>PWP3112</b>	<b>PWP3113</b>	<b>PWP4000A</b>		
					

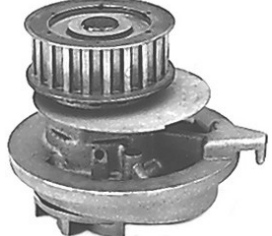
## HOLDEN

Make & Model	Eng Size	Type	Eng Model	Year	Part No.
<b>PWP4072</b>	<b>PWP5000</b>	<b>PWP5001</b> <i>Photo Not Available</i>			<b>PWP5012</b>
					
<b>PWP5013</b>	<b>PWP5014</b>	<b>PWP5019</b>			<b>PWP5020</b>
					
<b>PWP5023</b>	<b>PWP5072</b>	<b>PWP6380</b>			<b>PWP7022</b>
					
<b>PWP7023</b>	<b>PWP7031</b>	<b>PWP7040</b>			<b>PWP7050</b>
					
<b>PWP7220</b>	<b>PWP7222</b>	<b>PWP8005</b>			<b>PWP8222</b>
					
<b>PWP9067</b>	<b>PWP9074</b>	<b>PWP9076</b>			<b>PWP9078</b>
					

# PWP2008 WATER PUMP CATALOGUE

## HOLDEN

Make & Model

Eng Size

Type

Eng Model

Year

Part No.

**PWP9081**



**PWP9082**



**HILLMAN - Refer CHRYSLER**

## HONDA

Make & Model	Eng Size	Type	Eng Model	Year	Part No.
--------------	----------	------	-----------	------	----------

### Accord

SJ (Without pulley)	1.6L		EF	1977 - 79	<b>PWP831</b>
SJ (With pulley)	1.6L		EF	1977 - 79	<b>PWP831WP</b>
SM	1.6L	35mm dia. hub	EL	1979 - 81	<b>PWP854</b>
SJ, SM, SY, SZ	1.6, 1.8L	45mm dia. hub	EK, EP	1981 - 83	<b>PWP855</b>
AC, AD	1.8L		ES	1984 - 85	<b>PWP818</b>
AD, CA5	2.0L		A20A	1986 - 89	<b>PWP2007</b>
CB, CD	2.2L	SOHC	F22A	11/89 - 12/97	<b>PWP3016</b>
CG5	2.3L	Vtec	F23A	12/1997 on	<b>PWP3016</b>
CD	2.2L	64mm dia. hub	H22A	1992 on	<b>PWP4014</b>
CC	2.3L	56mm dia. hub	H23A	1993 on	<b>PWP3087</b>
CG1	3.0L	V6 Vtec	J30A	12/97 - 05/03	<b>PWP7037</b>
CL9, CM	2.4L	16V DOHC	K24A	06/2003 on	<b>PWP6060</b>

### City

VF	1.2L		ER	1979 - 86	<b>PWP907</b>
----	------	--	----	-----------	---------------

### Civic

SB, SF	1.2, 1.3L	4 Hole Mounting Body	EB	1973 - 79	<b>PWP828</b>
SB, SF (With pulley)	1.2, 1.3L	4 Hole Mounting Body	EB	1973 - 79	<b>PWP828WP</b>
SE (With pulley)	1.5L	5 Hole Mounting Body	EC, ED	1975 - 78	<b>PWP876WP</b>
SL, WC	1.3L		EN	1980 - 84	<b>PWP843</b>
AL, AN	1.5L		EW	1984 - 87	<b>PWP1120</b>
ED, EE, EG, EH	1.5, 1.6L		D15B	1987 on	<b>PWP1130</b>
EG, EH VTi -R	1.5L	V-Tech DOHC	D15Z	1993 - 09/95	<b>PWP3062</b>
EK	1.6L	SOHC	D16Y	1995 - 09/00	<b>PWP4011</b>
EK4	1.6L	DOHC	D16A	1995 - 03/99	<b>PWP4012</b>
EJ, ES, EU	1.7L	V-Tech OHC	D17A, D17Z	11/2000 on	<b>PWP8004</b>

### Concerto

MA2, 3 Exi	1.6L		D16A6	1988 - 92	<b>PWP1130</b>
------------	------	--	-------	-----------	----------------

### CR-V

RD1, 2	2.0L	DOHC	B20B	10/97 - 11/01	<b>PWP7012</b>
RD7	2.4L	DOHC	K24	12/2001 on	<b>PWP5016</b>

# PWP2008 WATER PUMP CATALOGUE

**HONDA**

Make & Model	Eng Size	Type	Eng Model	Year	Part No.
--------------	----------	------	-----------	------	----------

## CR-X

AG, AJ, AE, AH, AK, AF	1.3, 1.5L		EV, EW	1985 - 87	<b>PWP1120</b>
ED9	1.6L	SOHC	D16A	1987 - 92	<b>PWP1130</b>
EG2, EH	1.6L	DOHC	B16A	1992 - 95	<b>PWP3088</b>
EK	1.6L	DOHC	B16A	1995 on	<b>PWP4012</b>

## HR-V

GH	1.6L		D16W	2/99 on	<b>PWP7024</b>
----	------	--	------	---------	----------------

## Integra

AV, DA3	1.6L		D16A	1985 - 89	<b>PWP3017</b>
DA9, DC4	1.8L		B18AB	1989 - 92	<b>PWP3018</b>
DC2, VTi-R	1.8L	DOHC	B18C	1993 on	<b>PWP4012</b>
DC5	2.0L	Vtec	K20A3	09/01 - 03/04	<b>PWP6012</b>
DC5 Inc. Type R	2.0L	Vtec-s, Vtec-R	K20A2	09/01 - 03/04	<b>PWP8012</b>

## Jazz

GD	1.3 & 1.5L	Inc. Vti	L13A, L15A	10/02 on	<b>PWP1190</b>
----	------------	----------	------------	----------	----------------

## Legend

KA2, 3, 4	2.5L	V6	C25	1986 - 88	<b>PWP2025</b>
KA2, 3, 4	2.7L	V6	C27	1988 - 91	<b>PWP2025</b>
KA7, 8	3.2L	V6	G32A	1992 on	<b>PWP3063</b>
KA	3.5L	V6	C38A	1/96 - 12/97	<b>PWP7038</b>

## MDX

YD	3.5L	V6	A5	03/2003 on	<b>PWP8037</b>
----	------	----	----	------------	----------------

## Odyssey

RA1, 3	2.2, 2.3L	SOHC	F22, F23	6/95 - 3/00	<b>PWP3016</b>
RA6	2.3L		F23	3/2000 on	<b>PWP3016</b>
RA8	3.0L	V6	J30	3/2000 on	<b>PWP7037</b>

## Prelude

SN	1.6L	35mm dia. hub	EL	1979 - 81	<b>PWP854</b>
SN (5 Hole Mounting)	1.6L	45mm dia. hub	EL	1981 - 83	<b>PWP855</b>
SN (4 Hole Mounting)	1.6L		EL	1981 - 82	<b>PWP941</b>
AB	1.8L		ET	1983 on	<b>PWP818</b>
BA3	2.0L		A20A	1986 - 87	<b>PWP2007</b>
BA4	2.0L		B20A	1987 91	<b>PWP3019</b>
BA8, BB VTi-R	2.2L	SOHC	F22A	1992 on	<b>PWP3016</b>
BB2 (56mm dia. hub)	2.3L	19 Teeth	H23A	12/91 - 94	<b>PWP3087</b>

## HONDA











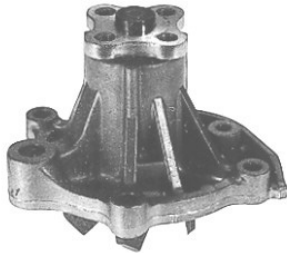

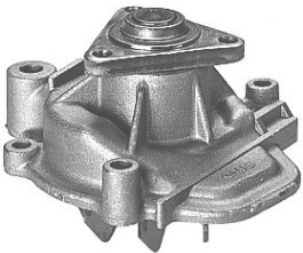

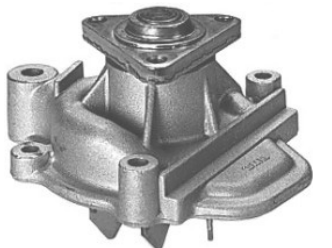
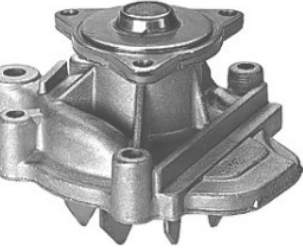

Make & Model	Eng Size	Type	Eng Model	Year	Part No.
--------------	----------	------	-----------	------	----------

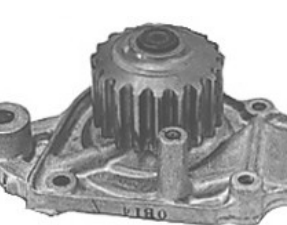
### Prelude Continued..

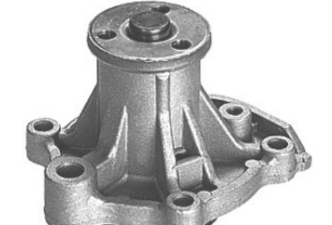
BB2 (64mm dia. hub)	2.2L	26 Teeth	H22A	2/94 - 12/96	<b>PWP4014</b>
BB5, 6	2.2L	SOHC	F22A	2/1997 on	<b>PWP7051</b>
BB5, 6 V-Tec	2.2L	V-Tec DOHC	H22A	2/1997 on	<b>PWP4014</b>











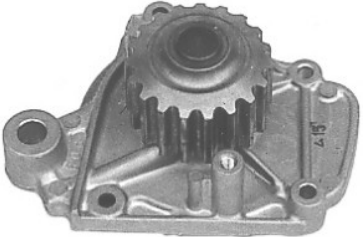

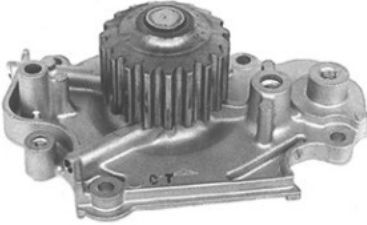

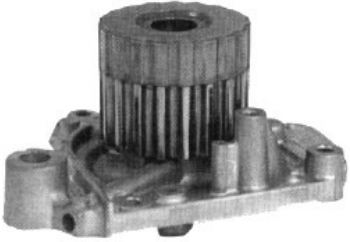
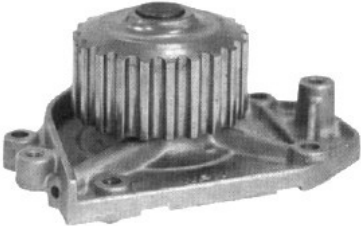
### S2000

S2000 Roadster	2.0L	V-Tec DOHC	F20C1	08/1999 on	<b>PWP7315</b>
----------------	------	------------	-------	------------	----------------

<b>PWP818</b> 	<b>PWP828</b> 	<b>PWP828WP</b> 	<b>PWP831</b> 
<b>PWP831WP</b> 	<b>PWP843</b> 	<b>PWP854</b> 	<b>PWP855</b> 
<b>PWP876WP</b> 	<b>PWP907</b> 	<b>PWP941</b> 	<b>PWP1120</b> 
<b>PWP1130</b> 	<b>PWP1190</b> 	<b>PWP2007</b> 	<b>PWP2025</b> 
<b>PWP3016</b> 	<b>PWP3017</b> 	<b>PWP3018</b> 	<b>PWP3019</b> 

# PWP2008 WATER PUMP CATALOGUE

## HONDA

Make & Model	Eng Size	Type	Eng Model	Year	Part No.
<b>PWP3062</b> 	<b>PWP3063</b> 	<b>PWP3087</b> 	<b>PWP3088</b> 		
<b>PWP4011</b> 	<b>PWP4012</b> 	<b>PWP4014</b> 	<i>Photo Not Available</i>		
<b>PWP6012</b> <i>Photo Not Available</i>	<b>PWP6060</b> 	<b>PWP7012</b> 	<b>PWP7024</b> 		
<b>PWP7037</b> 	<b>PWP7038</b> 	<b>PWP7051</b> 	<b>PWP7315</b> 		
<b>PWP8004</b> 	<b>PWP8012</b> 				

## HYUNDAI

Make & Model	Eng Size	Type	Eng Model	Year	Part No.
--------------	----------	------	-----------	------	----------

### Accent

All Models	1.5L	DOHC	G4EC	6/00 on	<b>PWP7005</b>
------------	------	------	------	---------	----------------

### Coupe

FX, SFX	1.8L	DOHC	G4GM	8/96 - 8/99	<b>PWP7032</b>
FX, SFX	2.0L	DOHC	G4GF	8/96 - 8/99	<b>PWP7032</b>
FX	1.8L	DOHC	G4GM	9/99 on	<b>PWP7032</b>
FX	2.0L	DOHC	G4GF	9/99 on	<b>PWP7032</b>

### Elantra

XD	1.8, 2.0L	DOHC	G4GB, G4GC	11/00 - 12/03	<b>PWP7032</b>
----	-----------	------	------------	---------------	----------------

### Excel

HA	1.5L	SOHC	G4AJ	2/86 - 1/90	<b>PWP877</b>
UA, UF	1.5L	SOHC	G4DJ, G4EKR	2/90 - 1/98	<b>PWP877</b>
UF	1.5L	DOHC	G4FKR	1/98 - 3/00	<b>PWP7005</b>

### Getz

TB	1.3L	DOHC	G4EA1	08/02 on	<b>PWP8003</b>
	1.5L	DOHC	G4EC2	08/02 on	<b>PWP7005</b>

### Grandeur

XG	3.0L	DOHC	G6CTX	10/99 - 12/02	<b>PWP7025</b>
	3.5L	DOHC	G6CTX	12/02 - 09/05	<b>PWP7025</b>
	3.8L	DOHC	G6	10/05 on	<b>PWP8025</b>

### Lantra

All Models	1.6L	DOHC	G4CR	5/91 - 7/93	<b>PWP3020</b>
	1.6, 1.8L	DOHC	G4CN.	7/93 - 5/95	<b>PWP3060</b>
	1.8, 2.0L	DOHC	G4GM, G4GF	9/95 - 10/00	<b>PWP7032</b>

### Scoupe

UE Inc. Turbo	1.5L		G4EK	06/90 - 12/95	<b>PWP877</b>
---------------	------	--	------	---------------	---------------

### Santa Fe

Wagon	2.4L	DOHC	G4JSX	11/00 on	<b>PWP7026</b>
	2.7L	DOHC V6	G6EA	11/00 on	<b>PWP7002</b>

### Sonata

AF2, 3	2.4L		G4CS	1/89 - 10/91	<b>PWP1027</b>
AF3, DF3	3.0L	V6	G6AT	3/90 - 5/98	<b>PWP2040</b>
DF2	2.0L		G4CP	10/93 - 5/98	<b>PWP3060</b>
EF	2.0L		G4JP	08/98 - 09/01	<b>PWP7002</b>
	2.5L	V6	G6BVV	08/98 - 09/01	<b>PWP7325</b>



# PWP2008 WATER PUMP CATALOGUE

**HYUNDAI**

Make & Model	Eng Size	Type	Eng Model	Year	Part No.
--------------	----------	------	-----------	------	----------

**Sonata Continued..**

EF-B	2.7L	V6	G6BAY	10/2001 on	<b>PWP7325</b>
	2.4L	16V DOHC	G4JSY	10/2001 on	<b>PWP7002</b>

**Terracan**

HP	3.5L	V6	G6CU	11/2001 on	<b>PWP7400</b>
----	------	----	------	------------	----------------

**Tiburon**

HN	2.7L	V6	G6BA	03/2002 on	<b>PWP7325</b>
	2.0L		G4GC	03/2002 on	<b>PWP7325</b>

**Trajjet**

HM	2.7L	V6	G6BA	05/2000 on	<b>PWP7325</b>
----	------	----	------	------------	----------------

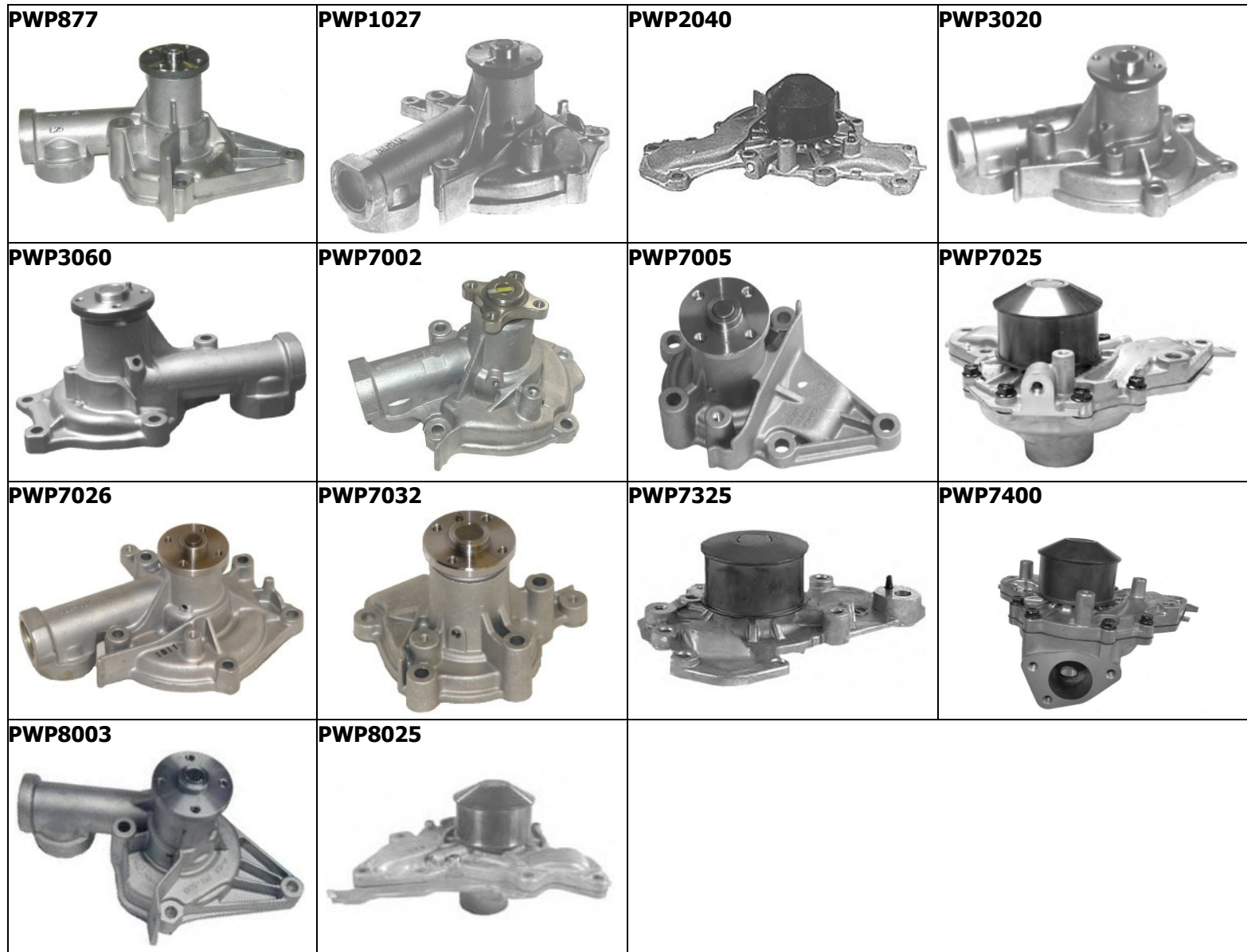

## INTERNATIONAL

Make & Model	Eng Size	Type	Eng Model	Year	Part No.
<b>Scout</b>					
4 Cyl.				1959 - 80	<b>PWP811</b>
6, 8 Cyl. models		266, 304, 345		1973 - 76	<b>PWP811</b>

### PWP811

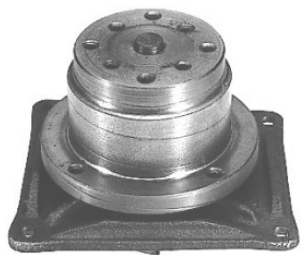

## ISUZU

Make & Model	Eng Size	Type	Eng Model	Year	Part No.
<b>FSR11</b>					
FSR450	5.8L		6BD1	1984 - 92	<b>PWP5006</b>
<b>FSR12</b>					
FSR500	6.5L		6BG1	1984 - 92	<b>PWP5006</b>
FSR650	6.5L		6BG1	1984 - 92	<b>PWP5006</b>
FSS12	6.5L		6BG1	1986 - 96	<b>PWP5006</b>
<b>FTR11/FTR12</b>					
FTR11	5.8L		6BD1	1984 - 90	<b>PWP5006</b>
FTR12	6.5L		6BG1	1984 - 92	<b>PWP5006</b>
<b>FTS12</b>					
FTS12	6.5L		6BG1	1974 - 86	<b>PWP5006</b>
<b>FVR11/FVR12</b>					
FVR11	5.8L		6BD1T	1984 - 86	<b>PWP5006</b>
FVR12	6.5L		6BG1	1984 - 86	<b>PWP5006</b>
<b>Imported</b>					
Imported	3.3L		4BA, 4BC	1979 on	<b>PWP2004</b>
<b>JBR</b>					
JBR	5.4L		6BB1	1976 - 80	<b>PWP3006</b>
<b>JCR/JCS</b>					
JCR	5.8L		6BD1, 6BD1-T	1978 - 80	<b>PWP3006</b>
JCR	5.8L		6BD1, 6BD1-T	1981 on	<b>PWP5006</b>
JCS420	5.8L		6BD1	1978 - 80	<b>PWP3006</b>
JCS	5.8L		6BD1	1983 on	<b>PWP5006</b>

# PWP2008 WATER PUMP CATALOGUE

**ISUZU**

Make & Model	Eng Size	Type	Eng Model	Year	Part No.
<b>KR32</b>					
KR32	3.9L		4BD1	1979 - 84	<b>PWP3003</b>
<b>KT25/KT26</b>					
Fan Height 125mm	3.3L		4BC1, 4BC2	1979 - 84	<b>PWP3004</b>
Fan Height 140mm	3.3L		4BC1, 4BC2	10/80 - 84	<b>PWP3002</b>
<b>NKR66</b>					
NKR150, 200	4.3L		4HF1	1996 - 02	<b>PWP6013</b>
NPR200, 250, 300, 400	4.3L		4HF1	1991 - 02	<b>PWP6013</b>
<b>NPR71</b>					
NPR250, 300 Crew Cab	4.6L	Crew Cab	4HG1	11/98 - 02	<b>PWP6013</b>
NPR250, 300 Medium	4.6L	Automatic	4HG1-T	11/98 - 02	<b>PWP6013</b>
<b>NPS66</b>					
NPS300	4.3L		4HF1	11/94 - 11/97	<b>PWP6013</b>
<b>NPS71</b>					
NPS250, 300	4.6L		4HG1	1997 - 03	<b>PWP6013</b>
<b>NQR70</b>					
NQR450	4.8L		4HE1-T	1998 - 02	<b>PWP6013</b>
<b>SBR</b>					
SBR	5.4L		6BB1	1975 on	<b>PWP3006</b>
<b>SCR</b>					
SCR	5.8L		6BD1	1/1981 on	<b>PWP5006</b>
<b>TLD</b>					
TLD	2.4L		C240	1972 - 74	<b>PWP3001</b>
TLD54 Crew Cab, TLD56	2.8L, 3.3L		4BA1, 4BC2	1976 - 84	<b>PWP3002</b>



## JAGUAR

Make & Model	Eng Size	Type	Eng Model	Year	Part No.
<b>XJ6</b>					
XJ6	3.8, 4.2L			1973 - 81	<b>PWP840</b>
XJ6 Series III	3.8, 4.2L			1981 - 87	<b>PWP880</b>

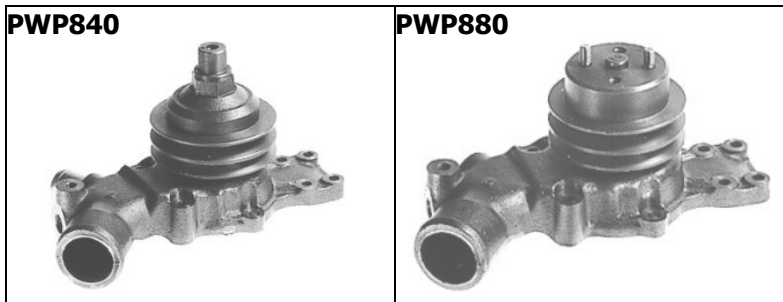

## JEEP

Make & Model	Eng Size	Type	Eng Model	Year	Part No.
<b>Cherokee</b>					
Cherokee Classic & Sport	2.5L	Diesel		07/87-02	<b>PWP2133</b>
Cherokee Classic & Sport	4.0L			4/1994 on	<b>PWP3133</b>
Cherokee Renegade & Sport	3.7L	V6		09/2001 on	<b>PWP8233</b>
Grand Cherokee	4.0L		MX	3/96 - 5/99	<b>PWP8133</b>
	4.7L	V8		6/1999 on	<b>PWP8233</b>
	4.0L			6/1999 on	<b>PWP7133</b>

## Wrangler

Wrangler	4.0L			10/96 - 2/00	<b>PWP8133</b>
	4.0L			3/2000 on	<b>PWP7133</b>

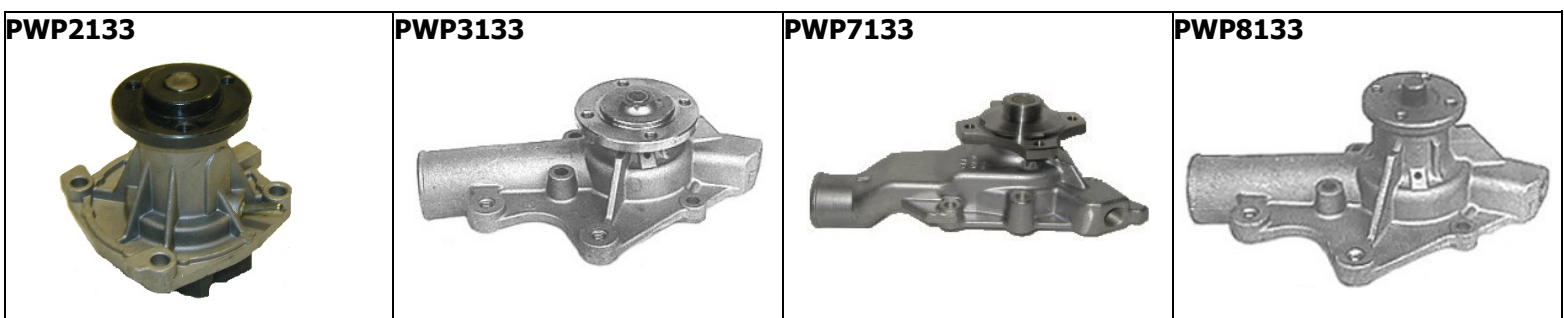





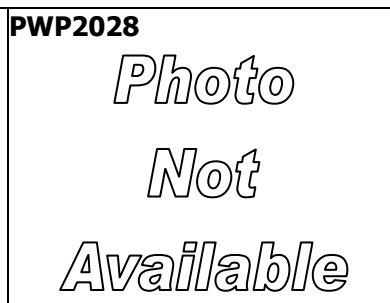

# PWP2008 WATER PUMP CATALOGUE

**KIA**

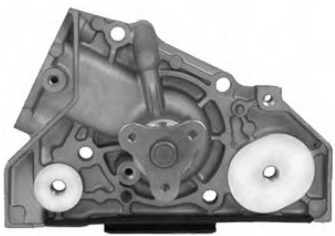
Make & Model	Eng Size	Type	Eng Model	Year	Part No.
<b>Carens</b>					
Carens	1.8L	DOHC	TB	07/00 - 08/02	<b>PWP7409</b>
<b>Carnival</b>					
Carnival	2.5L	V6	KV5	09/1999 on	<b>PWP7302</b>
<b>Ceres</b>					
Ceres	2.2L	Diesel	S2	6/92 - 7/96	<b>PWP1028</b>
Ceres	2.4L	Diesel		07/96 - 06/00	<b>PWP2028</b>
<b>Credos</b>					
Credos	2.0L	DOHC	FE	6/98 - 5/01	<b>PWP7095</b>
<b>Mentor</b>					
Mentor	1.5L	DOHC	B5	1/87 - 4/98	<b>PWP3230</b>
Mentor	1.5, 1.8L	DOHC	BE, TE	05/98 - 04/00	<b>PWP3010</b>
<b>Optima</b>					
Optima	2.5L	V6	G6BV	05/01 - 07/03	<b>PWP7325</b>
<b>Pregio</b>					
Pregio	2.7L	Diesel	J2	07/2002 on	<b>PWP7114</b>
<b>Rio</b>					
Rio	1.5L		A5D	07/00 - 12/02	<b>PWP7113</b>
	1.5L		A5D	01/2003 on	<b>PWP7299</b>
<b>Shuma</b>					
Shuma	1.6L		TE	04/00 - 04/01	<b>PWP7409</b>
<b>Sorento</b>					
Sorento	3.5L	DOHC	G6CU	02/2003 on	<b>PWP7400</b>
<b>Spectra</b>					
Spectra	1.8L	DOHC	TE	05/01 - 04/04	<b>PWP7409</b>
<b>Sportage</b>					
Sportage 4WD	2.0L	DOHC	FE	1/97 on	<b>PWP7095</b>

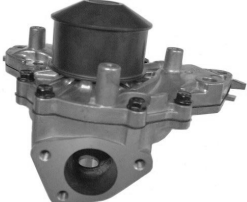

## KIA

Make & Model	Eng Size	Type	Eng Model	Year	Part No.
					
					

## LADA

Make & Model	Eng Size	Type	Eng Model	Year	Part No.
<b>Cevaro</b>					
Cevaro	1.3, 1.5L		2108	10/90 - 93	<b>PWP2591</b>
<b>Niva</b>					
Niva Inc. EFI	1.6L		BA33	7/83 - 7/95	<b>PWP972</b>
	1.7L		B05C	8/95 - 1/98	<b>PWP972</b>
<b>Sable</b>					
Sable	1.5L		2108	1/94 - 9/95	<b>PWP2591</b>
<b>Samara</b>					
Samara	1.3L		2108	7/88 - 10/90	<b>PWP2591</b>
<b>Volante</b>					
Volante	1.5L		2108	1/94 - 9/95	<b>PWP2591</b>

	
-------------------------------------------------------------------------------------	-------------------------------------------------------------------------------------



# PWP2008 WATER PUMP CATALOGUE

**LEXUS**

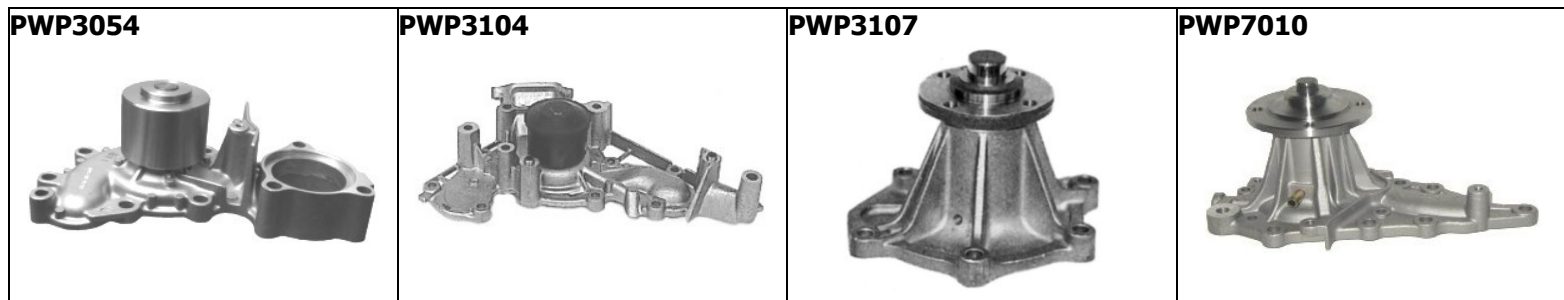
Make & Model	Eng Size	Type	Eng Model	Year	Part No.
<b>ES300</b>					
ES300	3.0L	V6	3VZ	6/92 - 9/96	<b>PWP3054</b>
ES300	3.0L	V6	1MZ-FE	10/1996 on	<b>PWP7035</b>
<b>GS300</b>					
GS300 24V	3.0L	DOHC V6	2JZ	10/1997 on	<b>PWP7010</b>
<b>IS200 / IS300</b>					
IS200 / IS300 - <b>Some</b> (Check Photo)	2.0L	DOHC	1G-FE	1983 - 94	<b>PWP7060</b>
IS200 / IS300	2.0L	DOHC	1G-FE	03/1999 on	<b>PWP8060</b>
IS200 / IS300	3.0L	Turbo	1JZ	03/1999 on	<b>PWP7042</b>
IS200 / IS300	3.0L	DOHC	2JZ	03/1999 on	<b>PWP7010</b>
<b>LS400</b>					
LS400	4.0L	V8	1UZ	05/90 - 11/00	<b>PWP3104</b>
<b>LS430</b>					
LS430	4.3L	V8	3UZ	12/2000 on	<b>PWP3104</b>
<b>LX450</b>					
LX450	4.5L		1FZFE	1996 - 97	<b>PWP3107</b>
<b>LX470</b>					
LX470	4.7L	V8	2UZ	5/1998 on	<b>PWP3104</b>
<b>SC300</b>					
SC300	3.0L	V6	2JZGE	1995 - 00	<b>PWP7010</b>
<b>SC400</b>					
SC400	4.0L	V8	1UZ	1991 on	<b>PWP3104</b>
<b>SC430</b>					
SC430	4.3L	V8	3UZ-FE	10/2001 on	<b>PWP3104</b>
<b>RX330</b>					
RX330	DOHC	V6	3MZ	03/2003 on	<b>PWP7035</b>



## LEXUS

Make & Model	Eng Size	Type	Eng Model	Year	Part No.
<b>PWP7035</b> 	<b>PWP7042</b> 	<b>PWP7060</b> 			

## LEYLAND

Make & Model	Eng Size	Type	Eng Model	Year	Part No.
<b>Austin</b>					
1800	1.8L			1964 - 73	<b>PWP738</b>
A40, Cambridge, Lancer	1.6L			5/62 - 4/70	<b>PWP178</b>
<b>Mini</b>					
850, Deluxe	850, 998cc			1960 - 76	<b>PWP3709</b>
Clubman all models	998, 1098cc			1960 - 79	<b>PWP3709</b>
Cooper & Cooper S	998, 1275cc			1971 - 76	<b>PWP3709</b>
<b>Morris</b>					
Major, Oxford	1.6L			1959 - 62	<b>PWP178</b>
Minor & Minor 1000	998cc			1959 - 61	<b>PWP3709</b>
1100, 1100 S	1098, 1275cc			1969 - 79	<b>PWP3709</b>

<b>PWP178</b> 	<b>PWP738</b> 	<b>PWP3709</b> 
-----------------------------------------------------------------------------------------------------	------------------------------------------------------------------------------------------------------	--------------------------------------------------------------------------------------------------------

## LOTUS

Make & Model	Eng Size	Type	Eng Model	Year	Part No.
<b>Lotus</b>					
Elise	1.8L	DOHC	18K	11/97 on	<b>PWP7056</b>

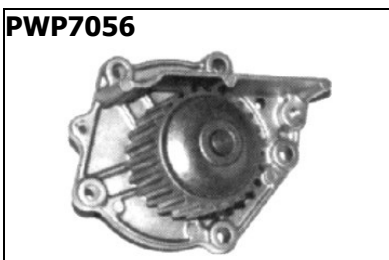



# PWP2008 WATER PUMP CATALOGUE

**MAZDA**

Make & Model	Eng Size	Type	Eng Model	Year	Part No.
--------------	----------	------	-----------	------	----------

## 121 Including Metro

CD2	1.8L		VC	1976 - 79	<b>PWP824</b>
CD5	2.0L		MA	1979 - 80	<b>PWP756</b>
DA	1.3L	SOHC	B3	1987 - 92	<b>PWP3230</b>
DB	1.3, 1.5L		VC	1990 - 95	<b>PWP3090</b>
Metro	1.3, 1.5L		B3,B5	8/96 on	<b>PWP3230</b>

## 323 Inc. Protege & Astina

FA4, 5 RWD	1.3, 1.4L		TC, UC	1977 - 80	<b>PWP902</b>
BD FWD	1.3, 1.5L		E3, E5	1980 - 85	<b>PWP852</b>
BF Turbo	1.6L	DOHC	B6	10/87 - 89	<b>PWP3010</b>
BG	1.8L	SOHC	B6, BP	1991 - 94	<b>PWP3230</b>
BG	1.6, 1.8L	DOHC	B6, BP	1989 - 94	<b>PWP3010</b>
BF, BG, BW	1.8L	SOHC	BP	1989 - 92	<b>PWP3230</b>
BA (Flat flange)	2.5L	V6	KF	1992 on	<b>PWP3075</b>
BA (Step flange)	2.5L	V6	KF	1992 on	<b>PWP3076</b>
BA	1.8L	DOHC	B6	7/94 - 8/98	<b>PWP3081</b>
BH	1.6, 1.8L	DOHC	BP	7/94 - 8/98	<b>PWP3081</b>
BJ	1.8, 2.0L	DOHC	FP, FS	10/98 on	<b>PWP3082</b>
BJ	1.6L	DOHC	ZM	10/98 on	<b>PWP3081</b>

## 626

CB RWD	2.0L		MA	1978 - 83	<b>PWP756</b>
GC (22mm round tooth pulley)	2.0L		FE	1983 - 87	<b>PWP893</b>
GC (19mm square tooth pulley)	2.0L		FE	1983 - 87	<b>PWP895</b>
GC	2.0L	Diesel	RF	1984 - 87	<b>PWP1018</b>
GD, GV	2.2L		F22	1987 - 92	<b>PWP2032</b>
GD, GE	2.0L	Diesel	RF	1987 - 97	<b>PWP8018</b>
GE, GF, GW	2.0L	DOHC	FS	8/97 on	<b>PWP3082</b>
EE, GF (Step Flange)	2.5L	V6	KL	1992 - 97	<b>PWP3076</b>
EF, GF (Flat Flange)	2.5L	V6	KL	1992 - 97	<b>PWP3075</b>

## 808

STC	1.3L		TC	1972 - 77	<b>PWP902</b>
SN	1.6L		NA	6/77 - 78	<b>PWP824</b>

## 929

LA	1.8L		VC	1973 - 79	<b>PWP824</b>
LA, HBSHE	2.0L		MA	1978 - 82	<b>PWP756</b>

## MAZDA

Make & Model	Eng Size	Type	Eng Model	Year	Part No.
--------------	----------	------	-----------	------	----------

### 929 Continued..

HBES	2.0L	19mm square tooth belt	FE	1984 - 87	<b>PWP895</b>
HBES	2.0L	22mm round tooth belt	FE	1984 - 87	<b>PWP893</b>
HC (With 17mm bearing)	3.0L	V6 SOHC	JE	5/87 - 7/91	<b>PWP3015</b>
HC (With 17mm bearing)	3.0L	V6 Quad cam	JE	5/87 - 7/91	<b>PWP8015</b>
HC (With 19mm bearing)	3.0L	V6 SOHC	JE	7/91 on	<b>PWP6015</b>
HD, HE (With 19mm bearing)	3.0L	V6 Quad cam	JE	7/91 - 3/96	<b>PWP7015</b>

### 1200

1200	1.2L		TA, TB	1968 - 73	<b>PWP830</b>
------	------	--	--------	-----------	---------------

### 1300

1300	1.3L		TC	1970 - 76	<b>PWP902</b>
------	------	--	----	-----------	---------------

### 1500

1500	1.5L		UB	1966 - 70	<b>PWP904</b>
------	------	--	----	-----------	---------------

### 1600/Capella

1600, Capella	1.6L		NA	1970 - 78	<b>PWP824</b>
---------------	------	--	----	-----------	---------------

### 1800

1800	1.8L		MA	1969 - 73	<b>PWP756</b>
------	------	--	----	-----------	---------------

### B Series

B1600 (Fixed fan)	1.6L		NA	1973 - 77	<b>PWP824</b>
B1800	1.8L		VC	1978 - 82	<b>PWP824</b>
B2000	2.0L		MA	1983 - 85	<b>PWP756</b>
B2000	2.0L	19mm square tooth belt	FE	1985 - 86	<b>PWP895</b>
B2000	2.0L	22mm round tooth belt	FE	1985 - 86	<b>PWP893</b>
B2000	2.0L		FE	1987 - 93	<b>PWP2032</b>
B2200	2.2L	OHV Diesel	S2	1978 - 84	<b>PWP1028</b>
B2200	2.2L	Diesel	F2	1988 - 90	<b>PWP2032</b>
B2200	2.2L	OHC Diesel	R2	1984 - 91	<b>PWP1018</b>
B2600	2.6L		4G54	1987 - 90	<b>PWP838</b>
B2600	2.6L		G6	1990 on	<b>PWP3123</b>
B2500	2.5L	OHC Diesel	WL	9/1996 on	<b>PWP3205</b>

### Bongo

F1000	1.0L			1966 - 68	<b>PWP902</b>
-------	------	--	--	-----------	---------------

### E Series

E1300, 1400	1.3,1.4L		TC, UC	1978 - 84	<b>PWP902</b>
E1400	1.4L		E5	1984 - 86	<b>PWP852</b>

# PWP2008 WATER PUMP CATALOGUE

## MAZDA

Make & Model

Eng Size

Type

Eng Model

Year

Part No.

### E Series Continued..

E1600 (Fixed fan)	1.6L		NA	1978 - 83	<b>PWP824</b>
E1800	1.8L	19mm square tooth belt	F8	1984 - 86	<b>PWP895</b>
E1800	1.8L	22mm round tooth belt	F8	1984 - 86	<b>PWP893</b>
E1800	1.8L		F8	1987 - 91	<b>PWP2032</b>
E2000	2.0L		VA	1979 - 81	<b>PWP2014</b>
E2000	2.0L	19mm square tooth belt	FE	1984 - 86	<b>PWP895</b>
E2000	2.0L	22mm round tooth belt	FE	1984 - 86	<b>PWP893</b>
E2000	2.0L		FE	1987 - 04	<b>PWP2032</b>
E2200	2.2L	OHV Diesel	S2	1978 - 84	<b>PWP1028</b>
E2200	2.2L	OHC Diesel	R2	1984 - 86	<b>PWP1018</b>
E2500, E2700, E3000	2.5, 2.7, 3.0L	Diesel	XA, XB, HA	1968 - 80	<b>PWP1140</b>
E2500	2.5L	Diesel	WL	10/99 on	<b>PWP3205</b>
E3000	3.0L	Diesel	HA	1980 on	<b>PWP1150</b>
E4100	4.1L	Diesel	ZB	1972 - 81	<b>PWP3014</b>

### Mazda 2

DY10Y1	1.5L	16V DOHC	ZY	12/2003 on	<b>PWP4230</b>
--------	------	----------	----	------------	----------------

### Mazda 3

BK10F1, BK1031	2.3L	16V DOHC	L3	01/04 on	<b>PWP4075</b>
----------------	------	----------	----	----------	----------------

### Mazda 6

GG1031, GY1031	2.3L	16V DOHC	L3	08/2002 on	<b>PWP4075</b>
----------------	------	----------	----	------------	----------------

### MPV

LV10, 11 (With 17mm bearing)	3.0L	V6 SOHC	JE	1993 - 12/95	<b>PWP3015</b>
LV11 (With 19mm bearing)	3.0L	V6 SOHC	JE	01/96 - 7/99	<b>PWP6015</b>
LV10 (With 17mm bearing)	3.0L	V6 DOHC	JE	01/96 - 7/99	<b>PWP8015</b>
LV10 (With 19mm bearing)	3.0L	V6 DOHC	JE	01/96 - 7/99	<b>PWP7015</b>
LW	2.5L	V6 DOHC	GY	8/99 on	<b>PWP7048</b>
LW	3.0L	V6 DOHC	AJ	6/02 on	<b>PWP7048</b>

### MX Series

MX5 NA	1.6L		B6	10/89 - 98	<b>PWP3010</b>
MX5 NA, NB	1.8L		B8	10/89 on	<b>PWP3081</b>
MX6 GE	2.2L		F22	1991 - 97	<b>PWP2032</b>
MX6 GD	2.5L	V6	KL	1992 on	<b>PWP3076</b>

### Premacy

BJ	1.8L	DOHC	FP	2/2001 on	<b>PWP3082</b>
----	------	------	----	-----------	----------------

## MAZDA

Make & Model	Eng Size	Type	Eng Model	Year	Part No.
--------------	----------	------	-----------	------	----------

### RX Series

RX2, RX3, RX4		6 mounting holes		1971 - 73	<b>PWP892</b>
RX2, RX3, RX4, RX5, RX7			12A	1973 - 85	<b>PWP851</b>
RX7			13B	1986 - 89	<b>PWP4017</b>
RX7 Turbo			13BT	1986 - 95	<b>PWP4018</b>
RX7 Twin Turbo			13BT	1992 on	<b>PWP4019</b>

### Tribute

YU	2.0L	DOHC	YF	02/01 - 01/04	<b>PWP8030</b>
YU	3.0L	V6	AJ	02/01 - 01/04	<b>PWP7048</b>
YU	2.3L	DOHC	L3	02/01-01/04	<b>PWP4075</b>

### T Series

T2600	2.6L		4G54	1985 - 88	<b>PWP838</b>
T3000	3.0L	Diesel	HA	1981 - 85	<b>PWP1150</b>
T3500	3.5L	Diesel	SL	1986 - 91	<b>PWP3013</b>
T4100	4.1L	Diesel	ZB	1981 - 91	<b>PWP3014</b>
T4000, T4600	4.0, 4.6L	Diesel	TF, TM	1989 - 95	<b>PWP4027</b>





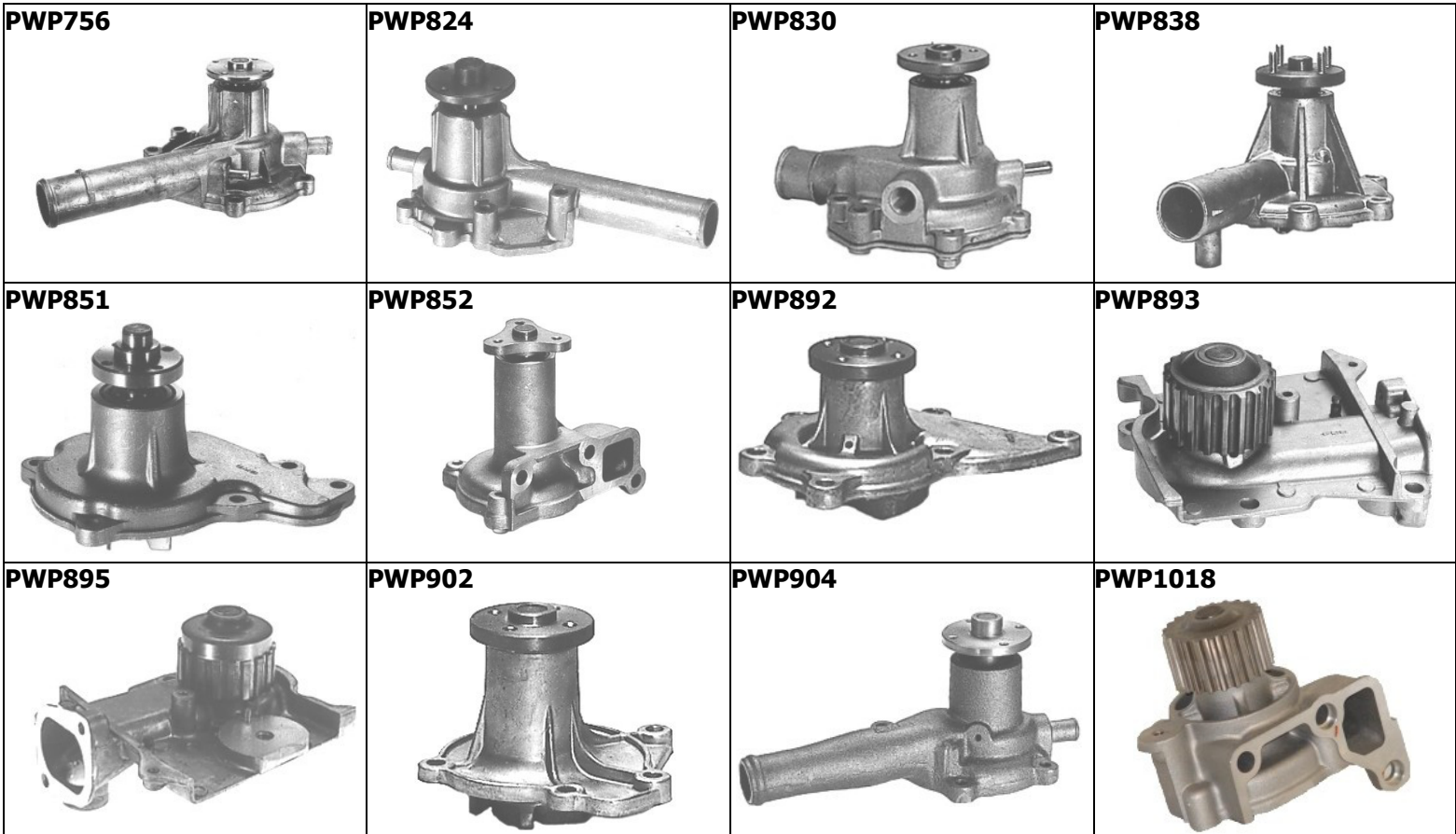









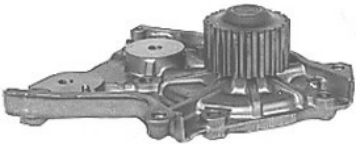
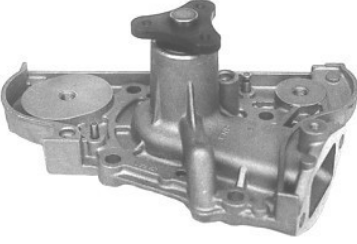

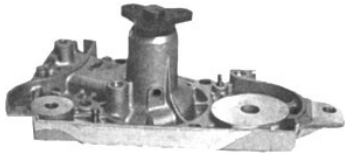



### Utility

1000, 1200 Utility	1.0,1.2L		TA,TB	1970 - 78	<b>PWP830</b>
--------------------	----------	--	-------	-----------	---------------

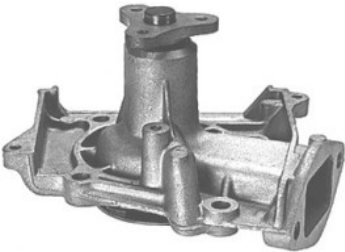





# PWP2008 WATER PUMP CATALOGUE

**MAZDA**

Make & Model	Eng Size	Type	Eng Model	Year	Part No.
<b>PWP1028</b>	<b>PWP1140</b>	<b>PWP1150</b>	<b>PWP2014</b>		
					
<b>PWP2032</b>	<b>PWP3010</b>	<b>PWP3013</b>	<b>PWP3014</b>		
					
<b>PWP3015</b>	<b>PWP3075</b>	<b>PWP3076</b>	<b>PWP3081</b>		
					
<b>PWP3082</b>	<b>PWP3090</b>	<b>PWP3123</b>	<b>PWP3205</b>		
					
<b>PWP3230</b>	<b>PWP4017</b>	<b>PWP4018</b>	<b>PWP4019</b>		
					
<b>PWP4027</b>	<b>PWP4075</b>	<b>PWP4230</b>	<b>PWP6015</b>		
					

## MAZDA

Make & Model	Eng Size	Type	Eng Model	Year	Part No.
<b>PWP7015</b> 	<b>PWP7048</b> 	<b>PWP8015</b> 	<b>PWP8018</b> 		
<b>PWP8030</b> 					

## MERCEDES-BENZ

Make & Model	Eng Size	Type	Eng Model	Year	Part No.
<b>A Class</b>					
A140, 160	1.4L			10/1998 on	<b>PWP7058</b>
A160	1.6L			10/1998 on	<b>PWP7058</b>
A160	1.6L			10/1998 on	<b>PWP7058</b>
<b>C Class (W202)</b>					
C180, C200, C220	1.8, 2.2L	DOHC		1993 on	<b>PWP4035</b>
C230 Kompressor	2.3L	DOHC		11/96 - 11/00	<b>PWP7061</b>
C240	2.4, 2.6L	SOHC		09/97 - 09/01	<b>PWP5035</b>
C250D	2.5L	Diesel		1994 - 11/96	<b>PWP5036</b>
C250TD	2.5L	Turbo Diesel		1994 - 02/00	<b>PWP8041</b>
C280	2.8, 3.2 L			9/93 - 97	<b>PWP3124</b>
C280	2.8L			08/97 - 11/00	<b>PWP5035</b>
C300D	3.0L	Diesel		1996 on	<b>PWP8040</b>
C300D	3.0L	Turbo Diesel		1996 on	<b>PWP8041</b>
C320	3.2L			11/00 on	<b>PWP5035</b>
<b>C114 Series</b>					
200	2.0 L			1968 - 73	<b>PWP995</b>
220	2.2 L			1968 - 73	<b>PWP995</b>
230	2.3 L			1968 - 73	<b>PWP995</b>
250	2.5 L			1968 - 73	<b>PWP995</b>
280	2.8 L			1968 - 72	<b>PWP995</b>

# PWP2008 WATER PUMP CATALOGUE

## MERCEDES-BENZ

Make & Model	Eng Size	Type	Eng Model	Year	Part No.
<b>C115 Series</b>					
200, 220	2.0, 2.2L			1959 - 68	<b>PWP560</b>
<b>C124 Series</b>					
300	3.0 L	DOHC		5/89 - 93	<b>PWP4036</b>
<b>C126 Series</b>					
380	3.8 L			2/82 - 86	<b>PWP3128</b>
500	5.0 L			2/82 - 86	<b>PWP3128</b>
<b>CLK S208</b>					
CLK200	2.0L		111940	10/1997 on	<b>PWP4035</b>
CLK200 Kompressor	2.0L		111940	10/1997 on	<b>PWP7061</b>
CLK230 Kompressor	2.3L		111973	10/1997 on	<b>PWP7061</b>
CLK320	3.2L		104995	10/1997 on	<b>PWP7062</b>
CLK430	4.3L		113943	10/1997 on	<b>PWP7062</b>
CLK500	5.0L	V8		06/02 on	<b>PWP5035</b>
CLK540	5.4L	V8		12/02 on	<b>PWP5035</b>
<b>E Class</b>					
E200K	2.0L	DOHC		08/00-09/02	<b>PWP7061</b>
E220	2.2L	DOHC		09/93-01/96	<b>PWP4035</b>
E230	2.3L	DOHC		01/96-01-98	<b>PWP7061</b>
E240	2.4L	DOHC		01/98 on	<b>PWP5035</b>
E280	2.8L	DOHC		01/93-01/96	<b>PWP3124</b>
E300D	3.0L	Turbo Diesel		10/93-01	<b>PWP8041</b>
E300D	3.0L	Diesel		1996 on	<b>PWP8040</b>
<b>M Class (W163)</b>					
ML230	2.3L		111977	9/98 on	<b>PWP4035</b>
ML320	3.2L		112942	9/98 on	<b>PWP7062</b>
ML430	4.3L		113942	9/98 on	<b>PWP7062</b>
<b>SLK Series</b>					
SLK200	2.0L		111946	1/97 - 6/00	<b>PWP4035</b>
SLK230	2.3L		111973	1/97 - 6/00	<b>PWP7061</b>
<b>T124 Series</b>					
200	2.0 L		111940	6/1992 on	<b>PWP4035</b>
220	2.2 L		111960	6/1992 on	<b>PWP4035</b>
<b>Vito</b>					
Vito 2.0i	2.0L	OHC	111948	2/1998 on	<b>PWP7065</b>
Vito 2.3i	2.3L	DOHC	111978	2/1998 on	<b>PWP7094</b>
Vito 2.3 D	2.3L	Diesel	601942	2/1998 on	<b>PWP7068</b>

## MERCEDES-BENZ

Make & Model	Eng Size	Type	Eng Model	Year	Part No.
--------------	----------	------	-----------	------	----------

### W116 Series

350	3.5L			1971 - 76	<b>PWP2376</b>
380	3.8L			1983 - 85	<b>PWP2376</b>
450	4.5L	V8		7/73 - 80	<b>PWP2376</b>

### W123 Series

250	2.5L			1976 - 78	<b>PWP1550</b>
-----	------	--	--	-----------	----------------

### W124 Series

200	2.0L			1993 - 1996	<b>PWP4035</b>
230	2.6-2.3L			2/86 - 93	<b>PWP1408</b>
260	2.6L			3/88 - 3/91	<b>PWP2563</b>
300	2.6L			3/86 - 93	<b>PWP2563</b>
300	3.0L	DOHC		5/89 - 93	<b>PWP4036</b>
300	3.0L			3/89 - 93	<b>PWP3124</b>
320	3.2L			3/89 - 93	<b>PWP3124</b>

### W126 Series

280	2.8 L			3/73 - 86	<b>PWP1550</b>
380	2.8, 5.0L			2/82 - 86	<b>PWP3128</b>
380	3.8 L	V8		12/80 - 86	<b>PWP3064</b>
420	4.2, 5.6L	V8		4/86 - 92	<b>PWP4038</b>
500	3.8, 5.0L	V8		2/82 - 86	<b>PWP3128</b>
560	4.2, 5.6L	V8		4/86 - 92	<b>PWP4038</b>

### W127 Series

280	2.8 L			3/73 - 86	<b>PWP1550</b>
-----	-------	--	--	-----------	----------------

### W140 Series

300	3.2L	V8		3/92 on	<b>PWP7063</b>
400	4.2, 5.0 L	DOHC		7/90 - 93	<b>PWP3064</b>
500	4.5, 5.0 L	DOHC		5/91 - 5/93	<b>PWP3064</b>















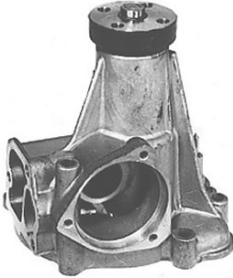



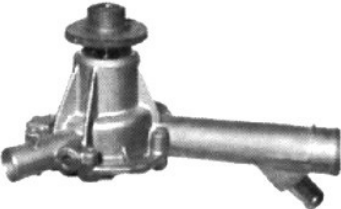

### W201 Series

190	1.8, 2.0, 2.3 L			9/90 - 3/94	<b>PWP1408</b>
190	2.6 L			6/89 - 91	<b>PWP1408</b>
190	2.0 L			12/84 - 90	<b>PWP2354</b>
C180, C200, C220	1.8, 2.2L	DOHC		1993 on	<b>PWP4035</b>
C280	2.8, 3.2 L			9/93 - 97	<b>PWP3124</b>
C280	2.8, 3.2 L			9/93 - 97	<b>PWP3124</b>



# PWP2008 WATER PUMP CATALOGUE

## MERCEDES-BENZ

Make & Model	Eng Size	Type	Eng Model	Year	Part No.
<b>PWP560</b>		<b>PWP995</b>		<b>PWP1408</b>	
<b>PWP1550</b>		<b>PWP2354</b>		<b>PWP2376</b>	
<b>PWP2563</b>		<b>PWP3064</b>		<b>PWP3124</b>	
<b>PWP3128</b>		<b>PWP4035</b>		<b>PWP4036</b>	
<b>PWP4038</b>		<b>PWP5035</b>	<i>Photo Not Available</i>	<b>PWP5036</b>	<i>Photo Not Available</i>
<b>PWP7058</b>		<b>PWP7061</b>		<b>PWP7062</b>	
<b>PWP7063</b>		<b>PWP7065</b>		<b>PWP7068</b>	
<b>PWP7094</b>		<b>PWP8040</b>		<b>PWP8041</b>	

## MERCEDES-BENZ

Make & Model	Eng Size	Type	Eng Model	Year	Part No.

## MG

Make & Model	Eng Size	Type	Eng Model	Year	Part No.
MG Midget	1098, 1275cc			1966 - 75	<b>PWP3709</b>
MGB	1.8L			1964 - 71	<b>PWP556</b>
	1.8L			1971 - 76	<b>PWP738</b>
MGF Inc. VVC	1.8L	DOHC	K4	3/1992 on	<b>PWP7056</b>

**PWP556**

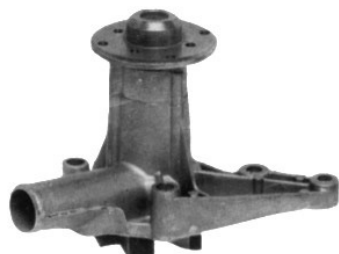

**PWP738**



**PWP3709**



**PWP7056**

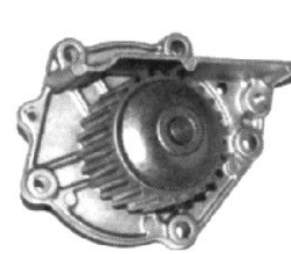

## MITSUBISHI

Make & Model	Eng Size	Type	Eng Model	Year	Part No.
<b>3000 GT</b>					
GT	3.0L	V6 DOHC	6G72	10/92 - 97	<b>PWP3093</b>
<b>Canter</b>					
FC 211, 212, 432	2.4, 2.6L		4G54	1979 - 91	<b>PWP1026</b>
FE	3.3L	Diesel	4D30	1979 - 82	<b>PWP914</b>
FE301, 305, 325, 335, 425, 431, 435	3.3L	Diesel	4D31	1985 - 91	<b>PWP1160</b>
FE339, 439, 539, 639 Inc.Turbo	3.9L	Diesel	4D33, 4D34	1991 - 07/96	<b>PWP4020</b>
FE516, 536, 566, 636, 639 Inc.Turbo	3.9, 4.2, 4.6L	Diesel	4D34, 35, 36	1993 on	<b>PWP4022</b>
FE511	2.8, 3.2L	Diesel	4M40, 4M41	05/98 - 11/02	<b>PWP3115</b>

# PWP2008 WATER PUMP CATALOGUE

## MITSUBISHI

Make & Model	Eng Size	Type	Eng Model	Year	Part No.
--------------	----------	------	-----------	------	----------

### Centura

KB, KC			Hemi	1975 - 78	<b>PWP802</b>
--------	--	--	------	-----------	---------------

### Challenger

PA	3.0L	V6	6G72	3/98 on	<b>PWP3096</b>
----	------	----	------	---------	----------------

### Colt

RA	1.4L		4G12	11/80 - 9/92	<b>PWP877</b>
----	------	--	------	--------------	---------------

RB, RC, RD, RE	1.4, 1.6L		4G33	10/82 - 90	<b>PWP878</b>
----------------	-----------	--	------	------------	---------------

### Cordia

AA	1.6L		4G32	1983 - 84	<b>PWP878</b>
----	------	--	------	-----------	---------------

AB, AC (Non-turbo)	1.8L		4G37	1984 on	<b>PWP878</b>
--------------------	------	--	------	---------	---------------

AA, AB, AC (Turbo)	1.8L		G62B	1984 on	<b>PWP1027</b>
--------------------	------	--	------	---------	----------------

### Delica

SF, SG, SH, SJ, WA	2.0, 2.4L		4G63B, 4G64	1990 - 94	<b>PWP6495</b>
--------------------	-----------	--	-------------	-----------	----------------

L300 SF, SG, SH, SJ	2.5L	Diesel	4D56	1986 - 95	<b>PWP1032</b>
---------------------	------	--------	------	-----------	----------------

SJ	2.5L	Diesel Turbo	4D56T	1993 - 09/00	<b>PWP3144</b>
----	------	--------------	-------	--------------	----------------

### FTO

FTO	2.5L		6A12	1993 - 96	<b>PWP3007</b>
-----	------	--	------	-----------	----------------

### Galant

GA, GB, GC, GD	1.3, 1.4, 1.6L		4G33	1971 - 77	<b>PWP822</b>
----------------	----------------	--	------	-----------	---------------

HG, HH	2.0L	SOHC	4G63	1989 - 91	<b>PWP1023</b>
--------	------	------	------	-----------	----------------

HH	2.0L	DOHC	4G63	1989 - 93	<b>PWP3060</b>
----	------	------	------	-----------	----------------

HH, VR4	2.0L	SOHC	4G63	1991 - 93	<b>PWP3061</b>
---------	------	------	------	-----------	----------------

HJ	2.0, 2.5L	V6	6A12, 13	1993 - 96	<b>PWP3007</b>
----	-----------	----	----------	-----------	----------------

### L Series Inc. Express

L200, D50, MA, MB, MC, MD	1.6L		4G32	5/79 - 84	<b>PWP1014</b>
---------------------------	------	--	------	-----------	----------------

L200 MA, MB	2.0L		4G52	5/79 - 82	<b>PWP838</b>
-------------	------	--	------	-----------	---------------

L200 MA, MB	2.6L		4G54	5/79 - 82	<b>PWP838</b>
-------------	------	--	------	-----------	---------------

L200 MC, MD	2.0L		4G63	1983 - 86	<b>PWP1023</b>
-------------	------	--	------	-----------	----------------

L200 MC, MD	2.3L	Diesel	4D55	1983 - 86	<b>PWP1032</b>
-------------	------	--------	------	-----------	----------------

L300 SA, SB, SC, SD, SE	1.6L		4G32	1980 - 86	<b>PWP1014</b>
-------------------------	------	--	------	-----------	----------------

L300 SB, SC, SD, SE	1.8L	8V OHC	4G62	1980 - 85	<b>PWP1023</b>
---------------------	------	--------	------	-----------	----------------

L300 SD, SE, SF	2.0L	8V OHC	4G63	1984 - 94	<b>PWP1023</b>
-----------------	------	--------	------	-----------	----------------

L300 SF, SG, SH, SJ	2.4L	8V OHC	4G64	1986 - 95	<b>PWP1023</b>
---------------------	------	--------	------	-----------	----------------

L300 SJ, WA	2.4L	8V OHC	4G64	9/94 on	<b>PWP3095</b>
-------------	------	--------	------	---------	----------------

L300 SF, SG, SH, SJ	2.5L	Diesel	4D56	1989 - 95	<b>PWP1032</b>
---------------------	------	--------	------	-----------	----------------

## MITSUBISHI

Make & Model	Eng Size	Type	Eng Model	Year	Part No.
--------------	----------	------	-----------	------	----------

### Lancer

LA, LB (With timing chain)	1.4L		4G33	1974 - 79	<b>PWP822</b>
LB, LC (With timing belt)	1.6L		4G32	1977 - 81	<b>PWP1014</b>
CA, CB	1.5L		G15B	8/88 - 9/92	<b>PWP877</b>
CB	1.6L		4G61	1990 - 92	<b>PWP3020</b>
CC	1.5L		4G15, 15B	10/92 - 5/96	<b>PWP877</b>
CC Inc. Turbo	1.6, 1.8L	16V DOHC	4G92, 93	1992 - 5/96	<b>PWP3092</b>
CD	2.0L		4G63	1992 - 5/96	<b>PWP3094</b>
CE	1.5L		4G15	5/96 - 5/00	<b>PWP7007</b>
CE	1.8L	16V SOHC	4G93	5/96 - 07/03	<b>PWP7064</b>
CG, CH	2.0L	16V SOHC	4G94	2/2003 on	<b>PWP7064</b>

### Magna

TM, TN, TP, TR, TS	2.6L	SOHC With Housing	4G54	1986 - 97	<b>PWP1025</b> <b>PWP1025A</b>
TR, TS	3.0L	V6	6G72	4/93 - 97	<b>PWP2040</b>
TE, TF, TH	3.0L	V6 DOHC	6G72	03/96 - 08/00	<b>PWP3096</b>
TE, TF	2.4L		4G64	3/96 - 12/98	<b>PWP7014</b>
TH	3.5L	V6 DOHC	6G74	3/1999 on	<b>PWP3096</b>
TJ, TL	3.0, 3.5L	V6 DOHC	6G72, 74	08/2000 on	<b>PWP3096</b>

### Mirage

CE	1.5L		4G15	7/1996 on	<b>PWP7007</b>
----	------	--	------	-----------	----------------

### Nimbus

UA, UB	1.7L		4G37	1984 - 87	<b>PWP878</b>
UC	2.0L		4G63	1987 - 92	<b>PWP1023</b>
UC	2.2L		3G63	1987 - 92	<b>PWP3094</b>
UD, UF	2.4L		4G64	1992 - 11/98	<b>PWP3061</b>
UG	2.4L		4G64	11/98 - 05/04	<b>PWP7014</b>

### Outlander

ZE, ZF	2.4L		4G64	12/02 - 05/04	<b>PWP9000</b>
ZE, ZF	2.4L		4G64	06/2004 on	<b>PWP9001</b>

# PWP2008 WATER PUMP CATALOGUE

## MITSUBISHI

Make & Model	Eng Size	Type	Eng Model	Year	Part No.
<b>Pajero</b>					
NA, NB, NC	2.3L	Diesel	4D55	1983 - 87	<b>PWP1032</b>
NA, NB, NC, ND	2.6L		4G54	1983 - 85	<b>PWP838</b>
NC, ND, NE, NF, NG	2.5L	Diesel	4D56	1987 - 93	<b>PWP1032</b>
ND, NE, NF, NG, NH	2.5L	Diesel Turbo	4D56T	10/86 - 93	<b>PWP1032</b>
NE, NF, NG, NH	2.6L		4G54	1987 - 91	<b>PWP838</b>
NF, NG, NH, NJ, NK	3.0L	V6 OHC	6G72	1988 - 93	<b>PWP2040</b>
NJ, NH Inc. Turbo	2.8L	Diesel	4M40	1993 - 02	<b>PWP3115</b>
NJ, NK	3.5L	V6 DOHC	6G74	1993 - 8/97	<b>PWP3116</b>
NJ, NK, NL Inc. Turbo	2.5L	Diesel Turbo	4D56T	1993 - 09/00	<b>PWP3144</b>
NL	3.5L	V6 OHC	6G74	9/97 - 04/00	<b>PWP3096</b>
NM, NP	3.5, 3.8L	V6 OHC	6G74	05/2000 on	<b>PWP4096</b>
NM, NP	2.8, 3.2L	Diesel	4M40, 4M41	05/2000 on	<b>PWP3115</b>
Pajero iO QA	1.8, 2.0L		4G93, 4G94	3/1999 on	<b>PWP3092</b>
Pajero iO QA	1.6L		4G18	3/1999 on	<b>PWP7007</b>
<b>RVR</b>					
N11W	1.8L		4G93	91 - 97	<b>PWP3092</b>
N13W	2.0L		4G63	91 - 92	<b>PWP3060</b>
N13W	2.0L		4G63	92 - 97	<b>PWP3094</b>
<b>Scorpion</b>					
Scorpion		1.9, 2.0, 2.6L		1977 - 87	<b>PWP838</b>
<b>Sigma</b>					
GE (With Timing chain)	1.6L		4G32	1977 - 79	<b>PWP822</b>
GE, GH (With Timing belt)	1.6L		4G32	1977 - 80	<b>PWP1014</b>
GE to GN	2.0, 2.6L			1977 - 87	<b>PWP838</b>
<b>Starion</b>					
JA, JB, JD	2.0L		4G63	1982 - 87	<b>PWP1023</b>
JB, JD	2.0L	Turbo	4G63T	1983 - 87	<b>PWP1026</b>
<b>Starwagon</b>					
SF, SG	2.0L		4G63	1986 - 90	<b>PWP1023</b>
SF, SG	2.4L		4G64	1986 - 90	<b>PWP1023</b>
WA	2.5L	Diesel	4D56	1991 on	<b>PWP1032</b>
WA	3.0L	V6	6G72	1994 on	<b>PWP3096</b>
SH, SJ	2.0, 2.4L	16V OHC MPi	G63B, 4G64	1990 - 94	<b>PWP6495</b>
WA	2.0, 2.4L		G63B, 4G64	9/1994 on	<b>PWP3095</b>
WA	3.0 L	V6	6G72	9/1994 on	<b>PWP3096</b>
MY97	2.0, 2.4L		4G63	9/1997 - on	<b>PWP3061</b>

## mitsubishi

Make & Model	Eng Size	Type	Eng Model	Year	Part No.
<b>Triton</b>					
ME, MF, MG, MH, MJ	2.6L		4G54	1986 - 96	<b>PWP838</b>
ME, MF, MG, MH, MJ	2.5L	Diesel	4D56	1986 - 90	<b>PWP1032</b>
MH, MJ	3.0L	V6 SOHC	6G72	90 - 8/96	<b>PWP2040</b>
MH, MJ	2.5L	Diesel Turbo	4D56T	90 - 7/96	<b>PWP3144</b>
MK	2.4L		4G64	10/96 on	<b>PWP3095</b>
MK	2.8L	Diesel Inc. Turbo	4M40	1996 on	<b>PWP3115</b>
MK	3.0L	V6 DOHC	6G72	8/96 on	<b>PWP3096</b>











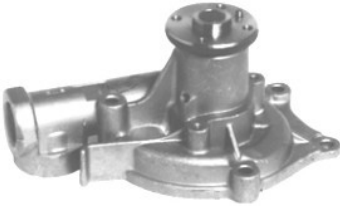

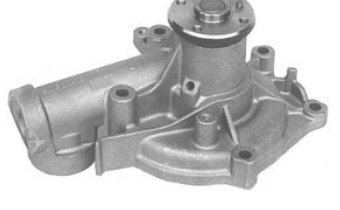

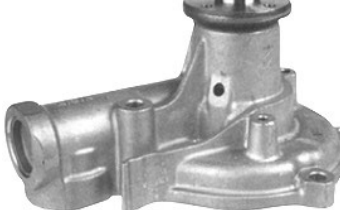

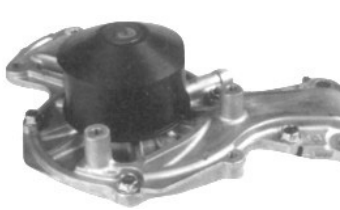

## Verada

KR, KS	3.0L	V6	6G72	8/91 - 3/97	<b>PWP2040</b>
KE, KF, KH, KJ	3.5L	V6	6G74	10/96 on	<b>PWP3096</b>



# PWP2008 WATER PUMP CATALOGUE

## MITSUBISHI

Make & Model	Eng Size	Type	Eng Model	Year	Part No.
<b>PWP3020</b>	<b>PWP3060</b>	<b>PWP3061</b>	<b>PWP3092</b>		
					
<b>PWP3093</b>	<b>PWP3094</b>	<b>PWP3095</b>	<b>PWP3096</b>		
					
<b>PWP3115</b>	<b>PWP3116</b>	<b>PWP3144</b>	<b>PWP4020</b>		
					
<b>PWP4022</b>	<b>PWP4096</b>	<b>PWP6495</b>	<b>PWP7007</b>		
					
<b>PWP7014</b>	<b>PWP7064</b>	<b>PWP9000</b>	<b>PWP9001</b>		
					

## NISSAN

Make & Model	Eng Size	Type	Eng Model	Year	Part No.
<b>120Y</b>					
120Y			A12	1974 - 79	<b>PWP788</b>
120Y (With fan clutch)			A12	1975 - 79	<b>PWP3011</b>
<b>180B</b>					
180B (Without air con)			L18	1972 - 77	<b>PWP752</b>
180B (With air con)			L18	1972 - 77	<b>PWP845</b>
<b>180SX</b>					
180SX S12	1.8L	DOHC	CA18DET	1982 - 88	<b>PWP889</b>
180SX S13	1.8L	DOHC	CA18DET	1988 - 91	<b>PWP889</b>
180SX S13	2.0L	DOHC	SR20DET	1991 - 93	<b>PWP6052</b>
<b>200B</b>					
200B (Without air con)			L20	1977 - 81	<b>PWP752</b>
200B (With air con)			L20	1977 - 81	<b>PWP845</b>
<b>200SX</b>					
200SX S13	2.0L	DOHC	SR20DET	1991 - 10/93	<b>PWP6052</b>
200SX S14	2.0L	DOHC	SR20DET	1993 - 10/00	<b>PWP3097</b>
200SX S15	2.0L	DOHC	SR20DET	12/00 on	<b>PWP3097</b>
<b>240C</b>					
240C			L24, 26, 28	1971 - 84	<b>PWP754</b>
<b>240K</b>					
240K			L24	1973 - 78	<b>PWP754</b>
<b>240Z</b>					
240Z			L24, 26, 28	1969 - 84	<b>PWP754</b>
<b>260C</b>					
260C			L24, 26, 28	1971 - 84	<b>PWP754</b>
<b>260Z</b>					
260Z			L24, 26, 28	1969 - 84	<b>PWP754</b>
<b>280C</b>					
280C			L24, 26, 28	1971 - 84	<b>PWP754</b>
<b>280ZX</b>					
280ZX			L24, 26, 28	1969 - 84	<b>PWP754</b>
<b>300C</b>					
300C		V6	VG30E	1983 - 89	<b>PWP928</b>
<b>300ZX</b>					
Z31	3.0L	V6	VG30E	1983 - 12/92	<b>PWP928</b>
300ZX Z32 Inc. Twin Turbo	3.0L	V6	VG30E	1992 - 10/96	<b>PWP3098</b>



# PWP2008 WATER PUMP CATALOGUE

**NISSAN**

Make & Model	Eng Size	Type	Eng Model	Year	Part No.
<b>350ZX</b>					
350ZX Z33	3.5L	V6	VQ35DET	12/2002 on	<b>PWP3145</b>
<b>520/620</b>					
520, 620	1.2, 1.5L			1965 - 79	<b>PWP837</b>
<b>720</b>					
720	1.8L		L18	1980 - 86	<b>PWP752</b>
720	2.2L	Diesel	SD22	1980 - 82	<b>PWP857</b>
720	2.3, 2.5L	Diesel	SD23, 25	1983 - 86	<b>PWP833</b>
720	2.2L		Z22	1983 - 86	<b>PWP754</b>
<b>1000/1200</b>					
1000, 1200			A10, A12	1967 - 74	<b>PWP788</b>
<b>1600</b>					
1600			L16	1968 - 72	<b>PWP752</b>
<b>2000/2300/2400</b>					
2000, 2300, 2400			L20, 23, 24	1966 - 70	<b>PWP754</b>
<b>B20/B120</b>					
B20, B120	1.0, 1.2L		A10, A12	1968 on	<b>PWP788</b>
<b>Bluebird</b>					
Series 1 & 2 (Without air con)	2.0L		L20	1981 - 85	<b>PWP752</b>
Series 1 & 2 (With air con)	2.0L		L20	1981 - 83	<b>PWP845</b>
Series 3	2.0L		CA20	1985 - 86	<b>PWP889</b>
U13	2.4L		KA24DE	1992 on	<b>PWP3099</b>
<b>Caball</b>					
C230 & C340	2.0L		H20	1967 - 82	<b>PWP844</b>
<b>Cabstar</b>					
EF20	2.2, 2.3L	Diesel	SD22, 23	1989 - 84	<b>PWP833</b>
F22	2.0L		Z20	1982 - 87	<b>PWP752</b>
H40	2.2L		Z22	1982 - 87	<b>PWP754</b>
EF22	2.5L	Diesel	SD25	1982 - 87	<b>PWP927</b>
AF22, H40	2.7L	Diesel	TD27	1987 - 91	<b>PWP3025</b>
H40, W40	3.3, 3.5L	Diesel	ED33, 35	1982 - 93	<b>PWP3026</b>
H40, W40	3.3, 3.5L	Diesel	ED33	5/82 - 93	<b>PWP4032</b>
H40, W40	3.3, 3.5L	Diesel	FD33, 35	5/82 - 93	<b>PWP4032</b>
W40	4.2L	Diesel	TD42	1991 on	<b>PWP6056</b>
<b>Civilian Bus</b>					
W40	4.2L	Diesel	TD42	1991 on	<b>PWP6056</b>

## NISSAN

Make & Model	Eng Size	Type	Eng Model	Year	Part No.
--------------	----------	------	-----------	------	----------

### EXA

KN13 Twin cam	1.6L		CA16DE	1986 - 87	<b>PWP889</b>
KN13 Twin cam (Large step hub)	1.8L		CA18DE	1987 - 92	<b>PWP3023</b>
KN13 Twin cam (Small step hub)	1.8, 2.0L		CA18, 20DE	1987 - 92	<b>PWP1170</b>

### Gazelle

S12	2.0L		CA20	1984 - 88	<b>PWP889</b>
-----	------	--	------	-----------	---------------

### Homer

PF20	2.0L		H20	1976 - 82	<b>PWP844</b>
T20	1.6L		J16	1972 - 75	<b>PWP837</b>

### Maxima

J30	3.0L	V6	VG30E	5/90 - 1/95	<b>PWP3024</b>
A32	3.0L	V6 DOHC	VQ30DE	1995 - 11/99	<b>PWP3145</b>
A33	3.0L	V6 DOHC	VQ30DE	12/1999 on	<b>PWP3145</b>

### Micra

K11E	1.3L		CG13DE	1995 on	<b>PWP3101</b>
------	------	--	--------	---------	----------------

### Navara

D21 (Without air con)	2.0, 2.4L		Z20,24	1986 - 3/97	<b>PWP752</b>
D21 (With air con)	2.4L		Z24	1986 - 3/97	<b>PWP754</b>
D21 EFI Model	2.4L		KA24E	6/92 - 3/97	<b>PWP3118</b>
D21	2.5L	Diesel	SD25	1986 - 88	<b>PWP927</b>
D21 (Twin pulley)	2.5L	Diesel	TD25	1988 - 91	<b>PWP3028</b>
D21 (Single pulley)	2.7L	Diesel	TD27	1988 - 91	<b>PWP3025</b>
D21	2.4L		Z24i	1991 - 5/92	<b>PWP3030</b>
D21 (With air con)	2.0L		Z20	1991 - 3/97	<b>PWP3058</b>
D21	3.0L	V6	VG30E	1992 - 3/97	<b>PWP928</b>
D21 Inc. Turbo	2.7L	Diesel	TD27	1992 - 3/97	<b>PWP3119</b>
D22	2.4L	SOHC	KA24E	3/97 - 6/99	<b>PWP3118</b>
D22	2.4L	DOHC	KA24DE	6/99 - 11/01	<b>PWP3099</b>
D22	3.0L	V6	VG30E	3/1997 on	<b>PWP928</b>
D22	2.7L	Diesel	TD27	03/97 - 11/01	<b>PWP3119</b>
D22	3.2L	Diesel	QD32	03/97 - 11/01	<b>PWP3119</b>
D22	3.0L	Diesel Turbo	ZD30	12/2001 on	<b>PWP7027</b>
D22	3.3L	V6	ZD30	12/01-12/06	<b>PWP7016</b>

# PWP2008 WATER PUMP CATALOGUE

## NISSAN

Make & Model	Eng Size	Type	Eng Model	Year	Part No.
--------------	----------	------	-----------	------	----------

### Nomad

GC22	2.4L		Z24	12/86 - 10/87	<b>PWP754</b>
GC22	2.4L		Z24S	10/87 - 92	<b>PWP3030</b>

### NX/NX-R

AB13 Coupe	2.0L	DOHC	SR20DE	1991 - 94	<b>PWP3050</b>
AB13 Coupe	2.0L	DOHC	SR20DE	94 - 5/95	<b>PWP6052</b>

### Pathfinder

WD21	2.4L		Z24	1986 - 92	<b>PWP754</b>
WD21 (With air con)	2.0L		Z20	1991 on	<b>PWP3058</b>
YD21	3.0L	V6	VG30E	1992 - 95	<b>PWP3120</b>
R50	3.3L	V6	VG33E	11/1995 on	<b>PWP7016</b>

### Patrol

G60	4.0L		P	1960 - 80	<b>PWP834</b>
MQ	3.3L	Diesel	SD33	1980 - 88	<b>PWP913</b>
MQ	2.8L		L28	1980 - 88	<b>PWP754</b>
MQ	4.0L		P40	1980 - 88	<b>PWP4021</b>
MQ	2.8L		L28	1980 - 88	<b>PWP754</b>
GQ	4.2L	Petrol	TB42	1988 - 98	<b>PWP6027</b>
GQ	4.2L	Diesel	TD42	1988 - 98	<b>PWP6056</b>
GQ RX	3.0L		RB30	1990 - 98	<b>PWP6071</b>
GQ	2.8L	Turbo Diesel	RD28T	02/92 - 12/97	<b>PWP4024</b>
GU	2.8L	Turbo Diesel	RD28T	12/97 - 03/00	<b>PWP4024</b>
GU	4.5L		TB45	12/92 - 3/00	<b>PWP7028</b>
GU Series 2	3.0L	Turbo Diesel	ZD30	4/2000 on	<b>PWP7027</b>
GU Series 2 Inc. Turbo	4.2L	Diesel	TD42	4/2000 on	<b>PWP6056</b>
GU Series 2	4.8L		TB48E	10/2001 on	<b>PWP7202</b>

### Pintara

R31	2.0L		CA20	1986 on	<b>PWP889</b>
U12	2.0L		CA20E	1989 - 92	<b>PWP3023</b>
U12	2.4L		KA24E	1989 - 92	<b>PWP3022</b>

### Prairie

M10	1.5L		E15	1982 - 85	<b>PWP888</b>
-----	------	--	-----	-----------	---------------

## NISSAN

Make & Model	Eng Size	Type	Eng Model	Year	Part No.
<b>Pulsar</b>					
N10	1.4L		A14	1980 - 81	<b>PWP788</b>
N10	1.3, 1.5L		E13, E15	1981 - 82	<b>PWP888</b>
N12	1.3, 1.5L		E13, E15	1982 - 86	<b>PWP888</b>
N13, Vector	1.6, 1.8L		16LF, 18LF	1987 - 91	<b>PWP881</b>
N14, N15	2.0L	DOHC	SR20DE	1991 - 6/00	<b>PWP3050</b>
N14, N15	1.6L	DOHC	GA16DE	1991 - 6/00	<b>PWP3053</b>
N14 GTiR 4WD	2.0L	Turbo	SR20DET	10/90 - 6/95	<b>PWP7001</b>
N16	1.6, 1.8L	DOHC	QG16,18	7/2000 on	<b>PWP7112</b>
B11 Van	1.3L		E13	1983 on	<b>PWP888</b>
<b>S-cargo</b>					
G20A Van	1.3, 1.5L		E13, E15	1986 on	<b>PWP3150</b>
<b>Serena</b>					
C23	2.0L		SR20DE	1991 - 12/95	<b>PWP3050</b>
AC23	2.0L		SR20DE	1994 on	<b>PWP6052</b>
<b>Silvia</b>					
S12	1.8L	DOHC	CA18DET	1982 - 88	<b>PWP889</b>
S12	2.0L	Inc. Turbo	FJ20	1982 - 88	<b>PWP7300</b>
S13	1.8L	DOHC	CA18DET	1988 - 91	<b>PWP889</b>
S13	2.0L	DOHC	SR20DT	1991 - 10/93	<b>PWP6052</b>
S14	2.0L	DOHC	SR20DET	1993 - 10/00	<b>PWP3097</b>
S15	2.0L	DOHC	SR20DET	12/2000 on	<b>PWP3097</b>
<b>Skyline</b>					
R30	2.0L	Inc. Turbo	FJ20	1982 - 86	<b>PWP7300</b>
C110 R30	2.4 L		L24E	1978 - 86	<b>PWP754</b>
R31 (Australian Production)	3.0 L		RB30E	1986 - 90	<b>PWP898</b>
R31, R32, GT-R, GTS	2.6 L	Inc. Turbo	RB26DET	8/85 - 8/93	<b>PWP898</b>
R33, R34, GTS, GT-R	2.5, 2.6 L	Inc. Turbo	RB25DET	1993 on	<b>PWP7054</b>
<b>Stanza</b>					
(Without air con)	1.6 L		L16	1978 - 83	<b>PWP752</b>
(With air con)	1.6 L		L16	1978 - 79	<b>PWP845</b>
<b>Sunny</b>					
(Without air con)	1.2, 1.4, 1.5L		A12, 14, 15	1979 - 81	<b>PWP788</b>
(With air con)	1.4, 1.5L		A14,15	1979 - 81	<b>PWP3011</b>

# PWP2008 WATER PUMP CATALOGUE

## NISSAN

Make & Model	Eng Size	Type	Eng Model	Year	Part No.
--------------	----------	------	-----------	------	----------

### Terrano II

R20	2.7L	Turbo Diesel	TD27T	11/96 - 12/99	<b>PWP3119</b>
R20	2.4L		KA24E	11/96 - 12/99	<b>PWP3118</b>

### Urvan

E20	2.0L		H20	1974 - 82	<b>PWP844</b>
E23	1.6L		J16	1982 - 84	<b>PWP837</b>
E23	2.0L		H20	1981 - 82	<b>PWP846</b>
E23	2.2, 2.3L	Diesel	SD22, 23	1981 - 86	<b>PWP857</b>
E23	2.0L		Z20	1982 - 86	<b>PWP754</b>
E24	2.4L		Z24	1982 - 87	<b>PWP754</b>
E24	2.4L		Z24S	1987 - 95	<b>PWP3030</b>
E24	2.7L	Diesel	TD27	1987 - 91	<b>PWP3025</b>
C24	2.4L		Z24	3/1997 on	<b>PWP754</b>
C24	2.7L	Diesel	TD27	3/1997 on	<b>PWP3025</b>

### Vanette

C20, C120	1.2L		A12	1982 - 84	<b>PWP788</b>
C20, C120 (With air con)	1.5L		A15	1985 - 86	<b>PWP3011</b>
C22	2.0L		Z20	1986 - 12/93	<b>PWP752</b>
G24	2.4L		Z24	1987 - 91	<b>PWP754</b>
VB11 Postal Van	1.3, 1.5L		E13, 15	1986 on	<b>PWP3150</b>

### X-Trail

T30 Wagon 4WD	2.5L	16V DOHC	QR25	10/2001 on	<b>PWP7401</b>
---------------	------	----------	------	------------	----------------













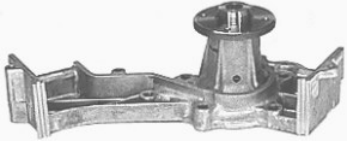
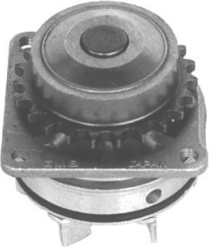

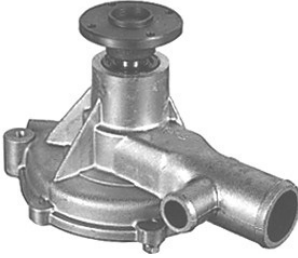







**NISSAN**

Make & Model	Eng Size	Type	Eng Model	Year	Part No.
<b>PWP846</b>	<b>PWP857</b>	<b>PWP881</b>	<b>PWP888</b>		
					
<b>PWP889</b>	<b>PWP898</b>	<b>PWP913</b>	<b>PWP927</b>		
					
<b>PWP928</b>	<b>PWP1170</b>	<b>PWP3011</b>	<b>PWP3022</b>		
					
<b>PWP3023</b>	<b>PWP3024</b>	<b>PWP3025</b>	<b>PWP3026</b>		
					
<b>PWP3028</b>	<b>PWP3030</b>	<b>PWP3050</b>	<b>PWP3053</b>		
					
<b>PWP3058</b>	<b>PWP3097</b>	<b>PWP3098</b>	<b>PWP3099</b>		
					

# PWP2008 WATER PUMP CATALOGUE

## NISSAN

Make & Model	Eng Size	Type	Eng Model	Year	Part No.
<b>PWP3101</b>	<b>PWP3118</b>	<b>PWP3119</b>	<b>PWP3120</b>		
					
<b>PWP3145</b>	<b>PWP3150</b>	<b>PWP4021</b>	<b>PWP4024</b>		
					
<b>PWP4032</b>	<b>PWP6027</b>	<b>PWP6052</b>	<b>PWP6056</b>		
					
<b>PWP6071</b>	<b>PWP7001</b>	<b>PWP7016</b>	<b>PWP7027</b>		
					
<b>PWP7028</b>	<b>PWP7054</b>	<b>PWP7112</b>	<b>PWP7202</b>		
					
<b>PWP7300</b>	<b>PWP7401</b>				
					

## PEUGEOT

Make & Model	Eng Size	Type	Eng Model	Year	Part No.
--------------	----------	------	-----------	------	----------

### 205

205 GTI, Si	1.6,1.9L		XU5,9	12/91 - 94	<b>PWP2891</b>
205 GTI	1.9L		XU9	10/87 - 12/91	<b>PWP3141</b>

### 206

206 1.4	1.4L	8V OHC	TU3JP	10/1999 on	<b>PWP7310</b>
206 1.6i	1.6L	8V OHC	TU	10/1999 on	<b>PWP4025</b>
206 1.6i	1.6L	16V DOHC	TU	10/1999 on	<b>PWP7301</b>
206 2.0i	2.0L	DOHC	TU	10/1999 on	<b>PWP7039</b>

### 306

306 1.8i	1.8L	SOHC	XU	4/94 - 97	<b>PWP2891</b>
306 1.8i	1.9L	SOHC	XU	3/94 - 7/97	<b>PWP4028</b>
306 1.9D	1.9L	Diesel	XUD	3/94 - 7/97	<b>PWP4028</b>
306 2.0i	2.0L	16V DOHC	TU	7/1997 on	<b>PWP7039</b>
306 1.8i	1.8L	SOHC	XU	7/1997 on	<b>PWP2891</b>
306 1.8i	1.8L	16V DOHC	XU	7/1997 on	<b>PWP7044</b>

### 307

307	1.6L		TU	12/01 on	<b>PWP7301</b>
307 Turbo	2.0L	Diesel	DW	12/01 on	<b>PWP7309</b>
307 Turbo	2.0L	16V	EW	2000 on	<b>PWP8309</b>

### 404

(Conventional fan)				1961 - 73	<b>PWP566</b>
(Disengaged fan)				1971 - 73	<b>PWP567</b>

### 405

405 1.9i	1.9L	SOHC	XU9	2/89 - 5/93	<b>PWP3141</b>
405 2.0i	2.0L	SOHC	XU10	5/93 - 96	<b>PWP4028</b>
405 1.9D	1.9L	Turbo Diesel	XUD9T	10/93 - 8/96	<b>PWP4030</b>
405 2.0i	2.0L	16V DOHC	XU10	2/89 on	<b>PWP2891</b>

### 406

406 2.0i	2.0L	16V DOHC	XU10	10/1996 on	<b>PWP7039</b>
406 3.0i	3.0L	V6	ES9	10/1996 on	<b>PWP7041</b>
406 2.1 TD	2.1L	Turbo Diesel	XUD11	10/1996 on	<b>PWP7074</b>
406 HDi	2.0L	Diesel	DW10	8/99 - 12/90	<b>PWP7069</b>
406 2.0i	2.0L	DOHC	XU10J4	8/99 - 12/90	<b>PWP4028</b>

### 407

407 2.0i	2.0L	Turbo Diesel	DW10	09/04 on	<b>PWP7101</b>
407 2.2i	2.2L	16V DOHC		09/04 on	<b>PWP7104</b>



# PWP2008 WATER PUMP CATALOGUE

**PEUGEOT**







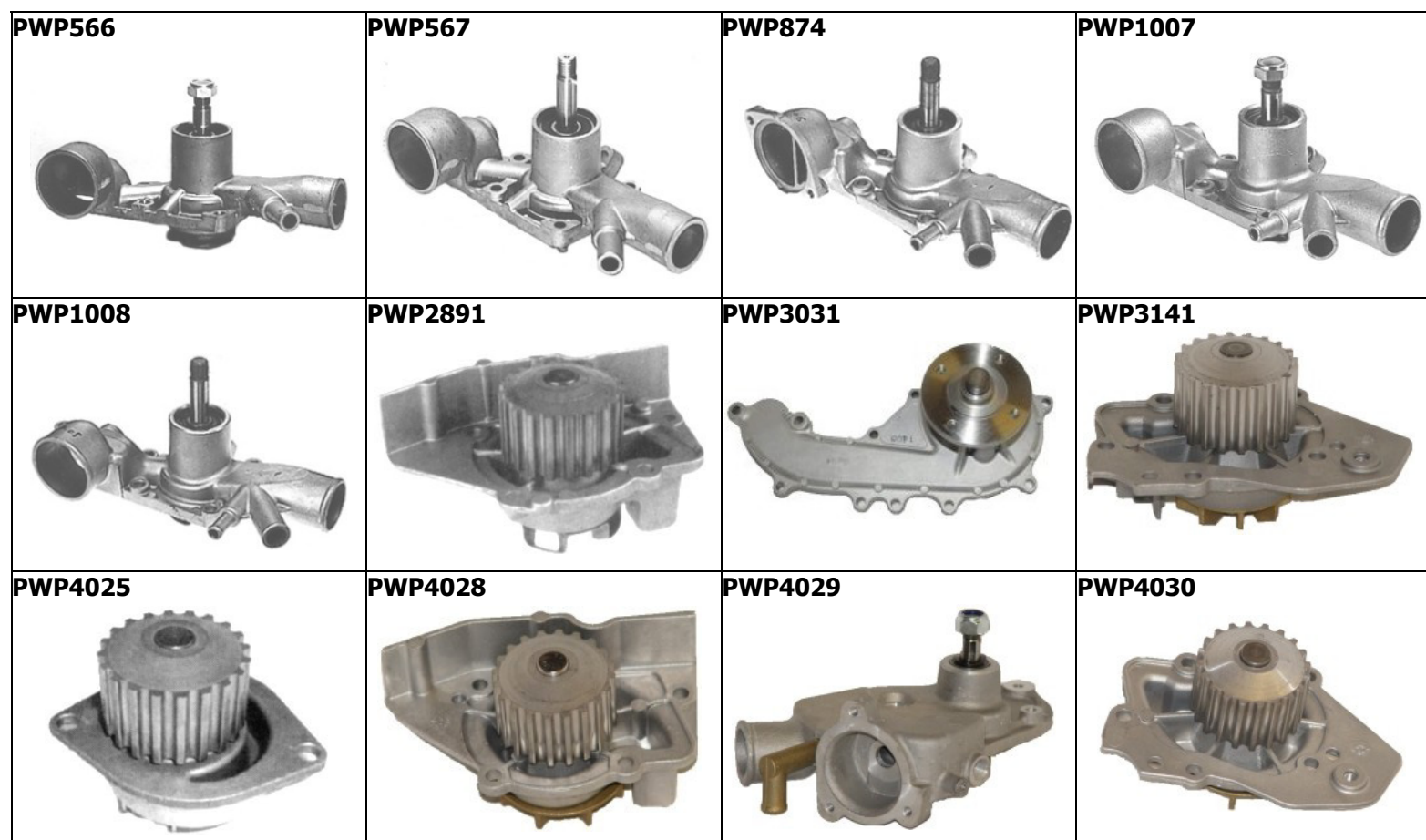





Make & Model	Eng Size	Type	Eng Model	Year	Part No.
<b>504</b>					
504 To chas. 2376842 Shaft length 138mm				1971 - 76	<b>PWP566</b>
504 From chas. 2376843				1977 - 78	<b>PWP1007</b>
504 To chas. 2376842 Shaft length 126mm				1971 - 76	<b>PWP567</b>
504 To chas. 2964000				1977 - 78	<b>PWP1008</b>
504	2.0L		XM7, XN2	1970/82	<b>PWP3031</b>
504 2.0i From chas. 2964001	2.0L		XN2	1979 - 8/82	<b>PWP874</b>

<b>505</b>					
505 2.0i	2.0L		XN1A	1979 on	<b>PWP874</b>
505 2.3D, 2.5D	2.3, 2.5L	Turbo Diesel	XD2S, DX3T	7/83 - 3/93	<b>PWP4029</b>
505 2.2i	2.2L		ZD	2/86 - 3/93	<b>PWP7073</b>
505 2.0i (With fan clutch)	2.0L		XN	2/86 - 3/93	<b>PWP874</b>

<b>605</b>					
605 3.0i	3.0L	V6	ZP	3/94 on	<b>PWP7071</b>
605 2.0i	2.0L	16V DOHC	XU10	10/96 on	<b>PWP7039</b>

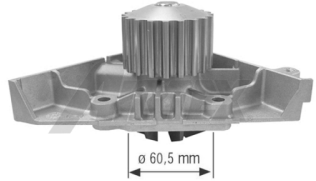

## PEUGEOT

Make & Model	Eng Size	Type	Eng Model	Year	Part No.
<b>PWP7039</b> 	<b>PWP7041</b> 	<b>PWP7044</b> 	<b>PWP7069</b> 		
<b>PWP7071</b> 	<b>PWP7073</b> 	<b>PWP7074</b> 	<b>PWP7101</b> 		
<b>PWP7104</b>  ø 60,5 mm	<b>PWP7301</b> 	<b>PWP7309</b> 	<b>PWP7310</b> 		
<b>PWP8309</b> 					

## PROTON

Make & Model	Eng Size	Type	Eng Model	Year	Part No.
<b>Persona</b>					
Persona	1.5L	SOHC	4G15	1995 on	<b>PWP877</b>
Persona	1.6L	SOHC	4G92	1995 on	<b>PWP3092</b>
<b>Satria</b>					
Satria	1.5L	SOHC	4G15	1995 on	<b>PWP877</b>
Satria	1.6L	SOHC	4G92	1995 on	<b>PWP3092</b>
Satria	1.8L	DOHC	4G93	9/1997 on	<b>PWP3092</b>

# PWP2008 WATER PUMP CATALOGUE

## PROTON

Make & Model	Eng Size	Type	Eng Model	Year	Part No.
<b>Wira</b>					
Wira	1.5L	SOHC	4G15	1995 on	<b>PWP877</b>
Wira	1.6L	SOHC	4G92	1995 on	<b>PWP3092</b>

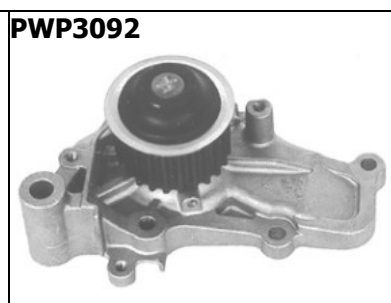

## RENAULT

Make & Model	Eng Size	Type	Eng Model	Year	Part No.
<b>Clio</b>					
Clio 1.4	1.4L	16V DOHC	K4J	12/01 on	<b>PWP8230</b>
Clio 1.6	1.6L	16V DOHC	K4M	12/01 on	<b>PWP8230</b>
Clio 2.0	2.0L	16V DOHC	F4R	05/01 on	<b>PWP998</b>

<b>Fuego</b>					
Fuego GTX, TX	2.0L		J6R	10/82 - 87	<b>PWP2474</b>
Fuego GTL 1.6	1.6L		A2M	4/83 - 10/86	<b>PWP2080</b>

<b>Kangoo</b>					
Kangoo X76	1.6L	16V DOHC	K4M	08/04 on	<b>PWP8230</b>

<b>Laguna</b>					
Laguna 2.0i	2.0L		F3R	3/95 - 9/96	<b>PWP3066</b>
Laguna 2.0i	2.0L	16V DOHC	F4R	03/02 on	<b>PWP8235</b>
Laguna 3.0i	3.0L	V6		3/95 - 9/96	<b>PWP9079</b>
Laguna 3.0i	3.0L	V6 24V	L7X	03/02 on	<b>PWP7041</b>

<b>Master</b>					
Master X70 Van	2.5L	Turbo Diesel	G9U	09/04 on	<b>PWP8000</b>

<b>Megane</b>					
Megane 1.6i X84	1.6L		K4M	2003 on	<b>PWP8230</b>
Megane 2.0i X84	2.0L	Turbo	F4R	2004 on	<b>PWP8235</b>

<b>R12</b>					
R12 Type 1170, 1171	1.3L			1970 - 76	<b>PWP769</b>

<b>R15</b>					
R15 Type 1300	1.3L			1969 - 72	<b>PWP769</b>

<b>R18</b>					
R18 GTS	1.8L			3/80 - 83	<b>PWP2080</b>

## RENAULT

Make & Model	Eng Size	Type	Eng Model	Year	Part No.
--------------	----------	------	-----------	------	----------

### R19

R19TXE, RT	1.7L		F3N,R	9/90 - 10/96	<b>PWP3066</b>
------------	------	--	-------	--------------	----------------

### R20

R20TS	2.0L			5/79 - 83	<b>PWP2078</b>
-------	------	--	--	-----------	----------------

### R21

R21TX	2.2L		J7T	3/88 - 6/89	<b>PWP2499</b>
R21 Marseille	2.2L		J7T	6/90 - 9/91	<b>PWP3065</b>

### R25

R25 GTS, GTX To chas. F241852	2.0L		J7R	7/85 - 92	<b>PWP3067</b>
R25 GTS, GTX From chas. F241853	2.0L		J7R	7/85 - 92	<b>PWP4067</b>
R25 Baccarra, Monaco	2.5, 2.7, 2.8L	V6	Z7W	9/90 - 9/91	<b>PWP2684</b>

### Scenic

Scenic 1.6i	1.6L		K4M	2003 on	<b>PWP8230</b>
Scenic 2.0i Inc. Dynamique Wagon	2.0L		F4R	2004 on	<b>PWP8235</b>
Grand Scenic 2.0i Inc. Dynamique Wagon	2.0L		F4R	12/07 on	<b>PWP8235</b>



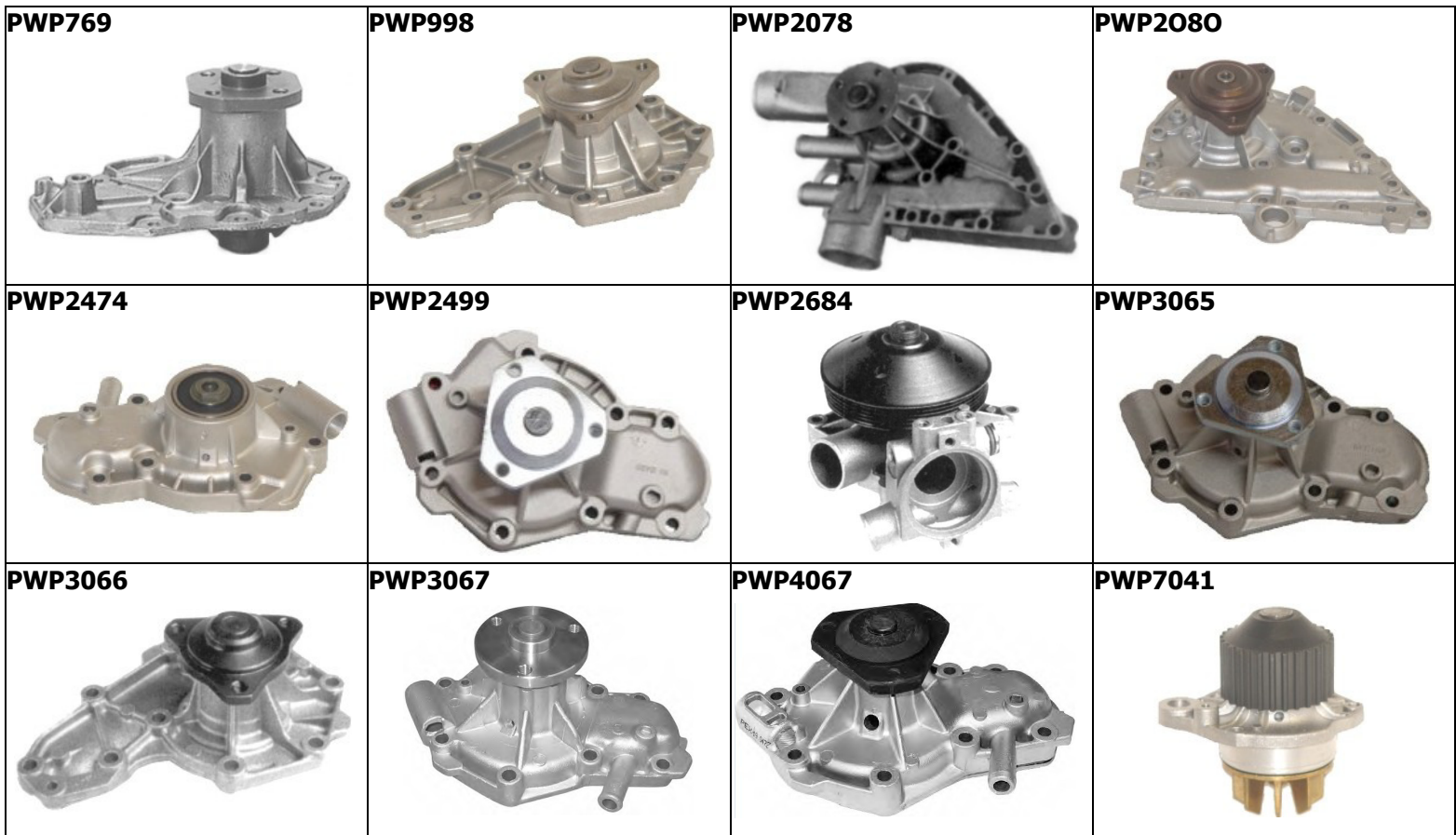

### Trafic

Trafic Van	1.9L	Diesel	F9Q	03/04 on	<b>PWP998</b>
------------	------	--------	-----	----------	---------------



# PWP2008 WATER PUMP CATALOGUE

## RENAULT

Make & Model	Eng Size	Type	Eng Model	Year	Part No.
<b>PWP8000</b> 	<b>PWP8230</b> 	<b>PWP8235</b> 	<b>PWP9079</b> 		

## ROVER

Make & Model	Eng Size	Type	Eng Model	Year	Part No.
<b>416i</b>					
416i	1.6L		D16A	5/86 - 90	<b>PWP3017</b>
<b>825i/827i</b>					
825i, 827i	2.5, 2.7L		C25, 27A	9/87 - 92	<b>PWP2025</b>
<b>3500</b>					
3500	3.5L	V8		1978 - 87	<b>PWP2095</b>
<b>Defender</b>					
Defender 90 Tdi 200	2.5L	Turbo Diesel	11L	6/92 - 12/94	<b>PWP7052</b>
Defender 90 Tdi 300	2.5L	Turbo Diesel	16L	01/95 - 03/98	<b>PWP8052</b>
Defender 90 3.5 (With fixed fan)	3.5l	V8	24G	9/90 - 12/94	<b>PWP2584</b>
Defender 90 3.5 (With fan clutch)	3.5l	V8	21G	9/90 - 12/94	<b>PWP2586</b>
Defender 90 3.5 (With air con)	3.5L	V8	21G	9/90 - 12/94	<b>PWP7057</b>
Defender 110, 130 Tdi 200	2.5L	Turbo Diesel	11L	90 - 12/94	<b>PWP7052</b>
Defender 110, 130 Tdi 300	2.5L	Turbo Diesel	16L	01/95 - 03/98	<b>PWP8052</b>
Defender 110, 130 3.5i (With air con)	3.5L	V8	21G	9/90 - 12/94	<b>PWP7057</b>
<b>Discovery</b>					
Discovery 2.5 Tdi 200	2.5L	Turbo Diesel	12L	10/89 - 6/94	<b>PWP7053</b>
Discovery 2.5 Tdi 300	2.5L	Turbo Diesel	18L	7/94 - 12/98	<b>PWP8052</b>
Discovery 2.5 Td5 5 Cyl.	2.5L	Turbo Diesel	10P	02/99 - 12/04	<b>PWP7052</b>
Discovery 3.5i	3.5 L	V8	22D	3/91 - 93	<b>PWP2614</b>
Discovery 3.9i - LA081990	3.9L	V8	36D	7/94 - 2/97	<b>PWP2614</b>

## ROVER

Make & Model	Eng Size	Type	Eng Model	Year	Part No.
--------------	----------	------	-----------	------	----------

### Discovery Continued..

Discovery 3.9 Tdi	3.9L	Diesel	4BD1	11/85 - 89	<b>PWP3004</b>
Discovery 3.9i	3.9L	V8	37D	2/1997 on	<b>PWP3714</b>
Discovery Series 3	4.4L	V8 DOHC	B109	03/05 on	<b>PWP4124</b>

### Freelander

Freelander 2.0 D	2.0L	Diesel	20T	3/1998 on	<b>PWP7055</b>
Freelander 1.8i	1.8L	16V	18K	3/98 - 10/00	<b>PWP7056</b>
Freelander 1.8i	1.8L	16V	18K	10/2000 on	<b>PWP8056</b>
Freelander 2.5	2.5L	V6 DOHC	K4FM	10/00 - 02/04	<b>PWP993</b>

### Landrover

11A, 111	2.3L	Petrol/Diesel		1961 - 81	<b>PWP216</b>
109, 110 (With fixed fan)	3.5L	V8	15G, 17G	3/80 - 90	<b>PWP2584</b>
109, 110 (With fan clutch)	3.5L	V8	F	9/90 - 12/94	<b>PWP2583</b>
110 County (With fan clutch)	3.5L	V8	G	11/84 - 2/91	<b>PWP2586</b>
110 County (With air con)	3.5L	V8	G	11/84 - 2/91	<b>PWP7057</b>
110 County	3.9L	Diesel	4BD	11/84 - 2/91	<b>PWP3004</b>

### Quintet

Quintet	1.6L		EL	1983 - 86	<b>PWP855</b>
---------	------	--	----	-----------	---------------

### Range Rover

Range Rover 3.5 (With fixed fan)	3.5L	V8	16D, 19D	6/72 - 85	<b>PWP2584</b>
Range Rover 3.5 (With fan clutch)	3.5L	V8	A, B	6/72 - 85	<b>PWP2581</b>
Range Rover 3.5 (With fan clutch)	3.5L	V8	C, E	6/72 - 85	<b>PWP2582</b>
Range Rover 3.5 (With fan clutch)	3.5L	V8	F	6/72 - 85	<b>PWP2583</b>
Range Rover 3.5i, 3.9i, 4.3i	3.5, 3.9, 4.3L	V8	37D, 38D	1986 - 04/94	<b>PWP2614</b>
Range Rover 4.0	4.0L	V8	37D, 38D	4/92 - 3/98	<b>PWP3714</b>
Range Rover Series 3	4.2, 4.4L	V8	448S	2004 on	<b>PWP4124</b>
Range Rover L322 HSE Inc. Vogue	4.4L	V8		08/02 on	<b>PWP8070</b>
Range Rover L322 HSE Inc. Vogue	2.9L	Turbo Diesel	306D	08/02 on	<b>PWP8071</b>

### Stirling











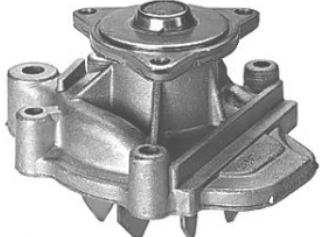

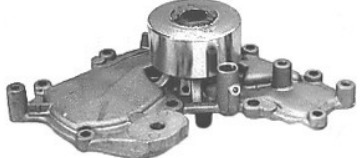





Stirling (800 Series)	1.6L		D16A3	1986 - 89	<b>PWP3017</b>
-----------------------	------	--	-------	-----------	----------------

### Vitesse

Vitesse	1.6L		D16A3	1986 - 89	<b>PWP3017</b>
---------	------	--	-------	-----------	----------------

# PWP2008 WATER PUMP CATALOGUE

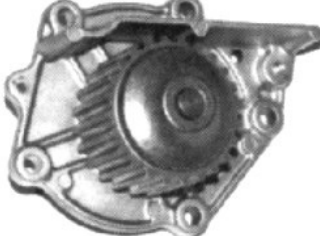
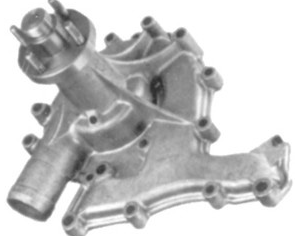
**ROVER**

Make & Model	Eng Size	Type	Eng Model	Year	Part No.
<b>PWP216</b>	<b>PWP855</b>	<b>PWP993</b>	<b>PWP2025</b>		
					
<b>PWP2095</b>	<b>PWP2581</b>	<b>PWP2582</b>	<b>PWP2583</b>		
					
<b>PWP2584</b>	<b>PWP2586</b>	<b>PWP2614</b>	<b>PWP3004</b>		
					
<b>PWP3017</b>	<b>PWP3714</b>	<b>PWP4124</b>	<b>PWP7052</b>		
		<p style="text-align: center;"><i>Photo Not Available</i></p>			
<b>PWP7053</b>	<b>PWP7055</b>	<b>PWP7056</b>	<b>PWP7057</b>		
					
<b>PWP8052</b>	<b>PWP8056</b>	<b>PWP8070</b>	<b>PWP8071</b>		
		<p style="text-align: center;"><i>Photo Not Available</i></p>	<p style="text-align: center;"><i>Photo Not Available</i></p>		

## SAAB

Make & Model	Eng Size	Type	Eng Model	Year	Part No.
<b>9.3</b>					
9.3 Inc. Turbo	2.0L	DOHC	B204I	7/98 on	<b>PWP7076</b>
9.3	2.3L	DOHC	B234I	7/98 on	<b>PWP7076</b>
<b>9.5</b>					
9.5 Inc. Turbo	2.0L	DOHC	B205E	11/97 on	<b>PWP7076</b>
9.5 Inc. Turbo	2.2L	DOHC	B235L	11/97 on	<b>PWP7076</b>
9.5 Turbo	3.0L	V6 DOHC	B308E	11/97 on	<b>PWP7022</b>
<b>99</b>					
99	2.0L	SOHC	H	1977 - 86	<b>PWP2180</b>
<b>900</b>					
900CI	2.0L	SOHC	H	1977 - 86	<b>PWP2180</b>
900 Inc. Turbo	2.0L	DOHC	B202	5/86 - 91	<b>PWP2663</b>
900	2.3L	DOHC	B234	3/91 - 98	<b>PWP2962</b>
900	2.1L	DOHC	B212	1/87 - 12/93	<b>PWP7077</b>
900S	2.5L	V6 DOHC	B256	02/94 - 06/98	<b>PWP7022</b>
<b>9000</b>					
9000	3.0L	V6 DOHC	B308	2/92 on	<b>PWP7022</b>
9000 Inc. Turbo	2.0L	DOHC	B202	5/86 - 91	<b>PWP2663</b>
9000	2.3L	DOHC	B234	3/91 - 98	<b>PWP2962</b>





# PWP2008 WATER PUMP CATALOGUE

## SEAT

Make & Model	Eng Size	Type	Eng Model	Year	Part No.
<b>Cordoba</b>					
Cordoba	1.8, 2.0L	SOHC	ADY, AB5, 2E	1/95 - 10/99	<b>PWP2453</b>
<b>Ibiza</b>					
Ibiza	1.8, 2.0L	SOHC	ADY, AB5, 2E	1/95 - 10/99	<b>PWP2453</b>
Ibiza	1.4L	SOHC	ABD	1/95 - 10/99	<b>PWP7127</b>
<b>Toledo</b>					
Toledo	1.8, 2.0L	SOHC	ADY, AB5, 2E	1/95 - 10/99	<b>PWP2453</b>
Toledo 16V	2.0L	DOHC	ABF	1995 - 98	<b>PWP2453</b>



## SSANGYONG

Make & Model	Eng Size	Type	Eng Model	Year	Part No.
<b>Korando</b>					
Korando 4WD	2.3L	DOHC	E23M161	1/98 - 02/00	<b>PWP1408</b>
Korando 4WD	3.2L	DOHC	E23	1/1996 on	<b>PWP7034</b>
Korando 4WD	2.9L	Turbo Diesel	OM662	1/1996 on	<b>PWP7068</b>
<b>Musso</b>					
Wagon 4WD	2.3L	DOHC	E23M161	10/1996 on	<b>PWP1408</b>
Wagon 4WD	3.2L	DOHC	E32	9/98 - 12/02	<b>PWP7034</b>
Wagon 4WD	2.5L, 2.9L	Turbo Diesel	OM662	9/98 - 12/02	<b>PWP7068</b>
Sports Dual Cab Ute	2.9L	Turbo Diesel	OM662	03/04 on	<b>PWP7068</b>
<b>Rexton</b>					
Y200, Y220 Wagon	2.9L	Turbo Diesel	OM662	06/2003 on	<b>PWP7068</b>
Y200, Y220 Wagon	2.7L	Turbo Diesel	OM162	06/2003 on	<b>PWP7068</b>



## SUBARU

Make & Model	Eng Size	Type	Eng Model	Year	Part No.
--------------	----------	------	-----------	------	----------

### Brumby

A69	1.6L		EA71	1978 - 80	<b>PWP849</b>
A69, AS	1.8L		EA81	1981 - 90	<b>PWP848</b>
AU	1.8L		EA81	10/80 - 94	<b>PWP848</b>

### Fiori

KM3, KN3	665cc		EK42	1985 - 89	<b>PWP2001</b>
KM3, KN3	758CC		EN08	11/89 - 12/92	<b>PWP2001</b>

### Forester

SF5	2.0L		EJ20	8/1997 on	<b>PWP3035</b>
SF5 GT	2.0L	Turbo	EJ20T	1998 on	<b>PWP3091</b>

### Heritage

CK	2.2L		EJ22	1991 - 05/94	<b>PWP3035</b>
----	------	--	------	--------------	----------------

### Impreza

GC	1.6, 1.8L		EJ16, 18	1993 - 96	<b>PWP3035</b>
WRX	1.8, 2.0L	DOHC Turbo	EJ20T	1994 on	<b>PWP3091</b>
GF8	2.0L	With two outlets	EJ20	8/98 - 4/03	<b>PWP4091</b>

### Leone

DL, GL, GF	1.4, 1.6L		EA64	1973 - 78	<b>PWP2001</b>
DL, GL	1.6L		EA71	1979 - 80	<b>PWP849</b>
DL, GL	1.8L		EA81	1980 - 84	<b>PWP848</b>
DL, GL	1.8L	Turbo	EA81	1982 - 85	<b>PWP1180</b>
DL, GL	1.8L		EA82	85 - 6/94	<b>PWP3033</b>
RX Turbo	1.8L		EA82	85 - 6/94	<b>PWP3034</b>

### Liberty

BC, BD, BF, BG	2.2L	OHC	EJ22	1988 on	<b>PWP3035</b>
BC5	2.0L	OHC	EJ20	9/91 - 5/94	<b>PWP3035</b>
BC5 RS Inc. Turbo	2.0L	DOHC	EJ20T	9/91 - 5/94	<b>PWP3091</b>
BD9	2.5L	With three outlets	EJ25	1996 on	<b>PWP3091</b>
GD, GA	2.0L	With two outlets	EJ20	08/00 - 08/03	<b>PWP4091</b>

### Outback

BG9	2.5L	With one outlet	EJ25	9/1996 on	<b>PWP6091</b>
BG9	2.5L	With three outlets	EJ25	9/96 - 6/98	<b>PWP3091</b>
BH9	2.5L	With three outlets	EJ25	11/1998 on	<b>PWP3091</b>
BH9	3.0L	With one outlet	EZ30	11/1998 on	<b>PWP6091</b>

### Sherpa

Sherpa	0.7L		EK42	1982 - 89	<b>PWP2001</b>
--------	------	--	------	-----------	----------------

# PWP2008 WATER PUMP CATALOGUE

## SUBARU

**Make & Model**

**Eng Size**

**Type**

**Eng Model**

**Year**

**Part No.**

### SVX

CX	3.3L	DOHC	EG33	3/92 - 97	<b>PWP3089</b>
----	------	------	------	-----------	----------------

### Vortex

Non Turbo	1.8L		E82	1985 - 90	<b>PWP3033</b>
Turbo	1.8L		EA82	1985 - 90	<b>PWP3034</b>

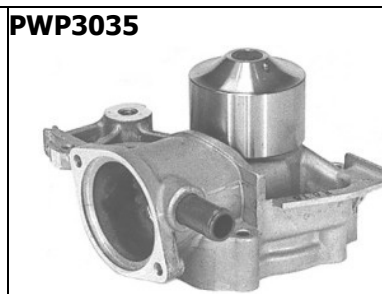
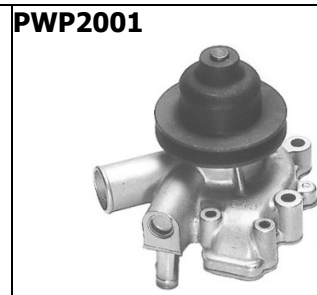
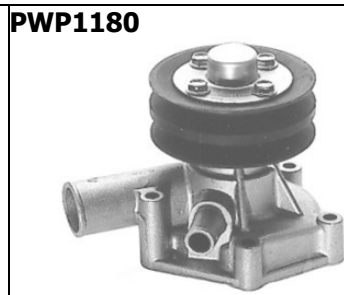
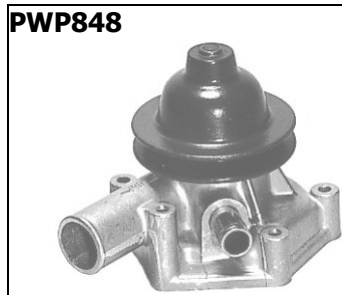

## SUZUKI

**Make & Model**

**Eng Size**

**Type**

**Eng Model**

**Year**

**Part No.**

### Alto

CA71, CA91	543, 796cc		F5A, F8B	1985 - 89	<b>PWP2013</b>
SS40, 80, AA41 (Without pulley)	543, 796cc		F5A, F8B	1980 - 85	<b>PWP2003</b>
SS40, 80, AA41 (With pulley)	543, 796cc		F5A, F8B	1980 - 85	<b>PWP2200</b>
CA	543, 796cc		F5A, F8B	1985 - 89	<b>PWP2013</b>
SH410	1.0L		G10B	3/1996 on	<b>PWP3037</b>

### Baleno

SY416	1.6L	OHC	G16B	4/95 - 12/98	<b>PWP3036</b>
SY416	1.6L		G16B	1/99 - 12/01	<b>PWP7097</b>
SY418	1.8L		J18A	02/97 - 04/01	<b>PWP8017</b>

## SUZUKI

Make & Model	Eng Size	Type	Eng Model	Year	Part No.
--------------	----------	------	-----------	------	----------

### Cappuccino

EA11R	657cc	DOHC	F6a	1990 on	<b>PWP6037</b>
-------	-------	------	-----	---------	----------------

### Carry

ST10, ST20 3 Cyl.	593cc		LJ50	1976 - 81	<b>PWP2002</b>
ST80V, ST90V (Without pulley)	797cc		F8A	1978 - 85	<b>PWP2003</b>
ST80V, ST90V (With pulley)	797cc		F8A	1978 - 85	<b>PWP2200</b>
SK410 Super Carry	1.0L		F10A	7/85 - 90	<b>PWP2013</b>
ST80, ST90, ST410	1.0L		F10A	1985 - 90	<b>PWP2013</b>
FD	1.3L		G13BB	06/1999 on	<b>PWP7110</b>

### Cino

SY413	1.3L		G13BA	5/1994 on	<b>PWP3037</b>
-------	------	--	-------	-----------	----------------

### Hatch

SS40, SS80	593, 797cc		F8A	1980 - 83	<b>PWP2003</b>
------------	------------	--	-----	-----------	----------------

### Ignis

HV, HX	1.3, 1.5L		M13A, M15A	11/2000 on	<b>PWP5012</b>
--------	-----------	--	------------	------------	----------------

### Jimny

JB	1.3L	OHC	G13BB	10/98 - 09/00	<b>PWP7110</b>
JB	1.3L	DOHC	M13A	10/2000 on	<b>PWP5012</b>

### Liana

RC31	1.6, 1.8L	DOHC	M16, M18	11/2001 on	<b>PWP5012</b>
------	-----------	------	----------	------------	----------------

### LJ Series

LJ50 3 Cylinder	593cc		LJ50	1974 - 78	<b>PWP2002</b>
LJ80, Stockman (Without pulley)	797cc		F8A	1978 - 81	<b>PWP2003</b>
LJ80, Stockman (With pulley)	797cc		F8A	1978 - 81	<b>PWP2200</b>

### Mighty Boy

SS40T	593cc		F5A	1982 - 88	<b>PWP2013</b>
-------	-------	--	-----	-----------	----------------

### Sierra

SJ410	1.0L		F10A	1981 - 85	<b>PWP2013</b>
SJ413	1.3L		G13A, G13BA	1985 - 12/98	<b>PWP3012</b>

### Swift

SA310 3Door Hatch	1.0L		G10A	1984 - 89	<b>PWP2008</b>
SA413	1.3L	DOHC	G13B	1986 - 88	<b>PWP3037</b>
SA413, SF310	1.3L		G13B	1989 - 92	<b>PWP3037</b>
SF Inc GTi	1.3L	SOHC & DOHC	G13BA, G13B	1989 on	<b>PWP3037</b>
SF310	1.0L		G10A	1989 - 94	<b>PWP3037</b>
SF416	1.6L	OHC	G16B	10/91 - 12/99	<b>PWP3036</b>
JB43	1.5L	DOHC	M15A	04/00 - 10/04	<b>PWP5012</b>

# PWP2008 WATER PUMP CATALOGUE

**SUZUKI**

Make & Model	Eng Size	Type	Eng Model	Year	Part No.
<b>Vitara</b>					
Vitara TA, TD	1.6L		G16A, B	1989 - 96	<b>PWP3036</b>
Vitara TA, TD	2.0L	4cyl.	J20A	5/97 - 4/00	<b>PWP8017</b>
Vitara TD	2.0L	V6	H20A	4/95 - 12/98	<b>PWP7017</b>
Grand Vitara Cabriolet 2 door	1.6L		G16B	1/00 - 9/00	<b>PWP7097</b>
Grand Vitara	2.0L	4cyl.	J20A	3/1998 on	<b>PWP8017</b>
Grand Vitara	2.5L	V6	H25A	3/1998 on	<b>PWP7017</b>
Vitara XL7	2.7L	V6	H27A	7/2001 on	<b>PWP7017</b>

<b>Wagon R+</b>					
Wagon R+	1.0L		G10B	10/97 - 12/98	<b>PWP3037</b>

<b>X-90</b>					
LB11	1.6L		G16B	4/96 - 6/98	<b>PWP3036</b>

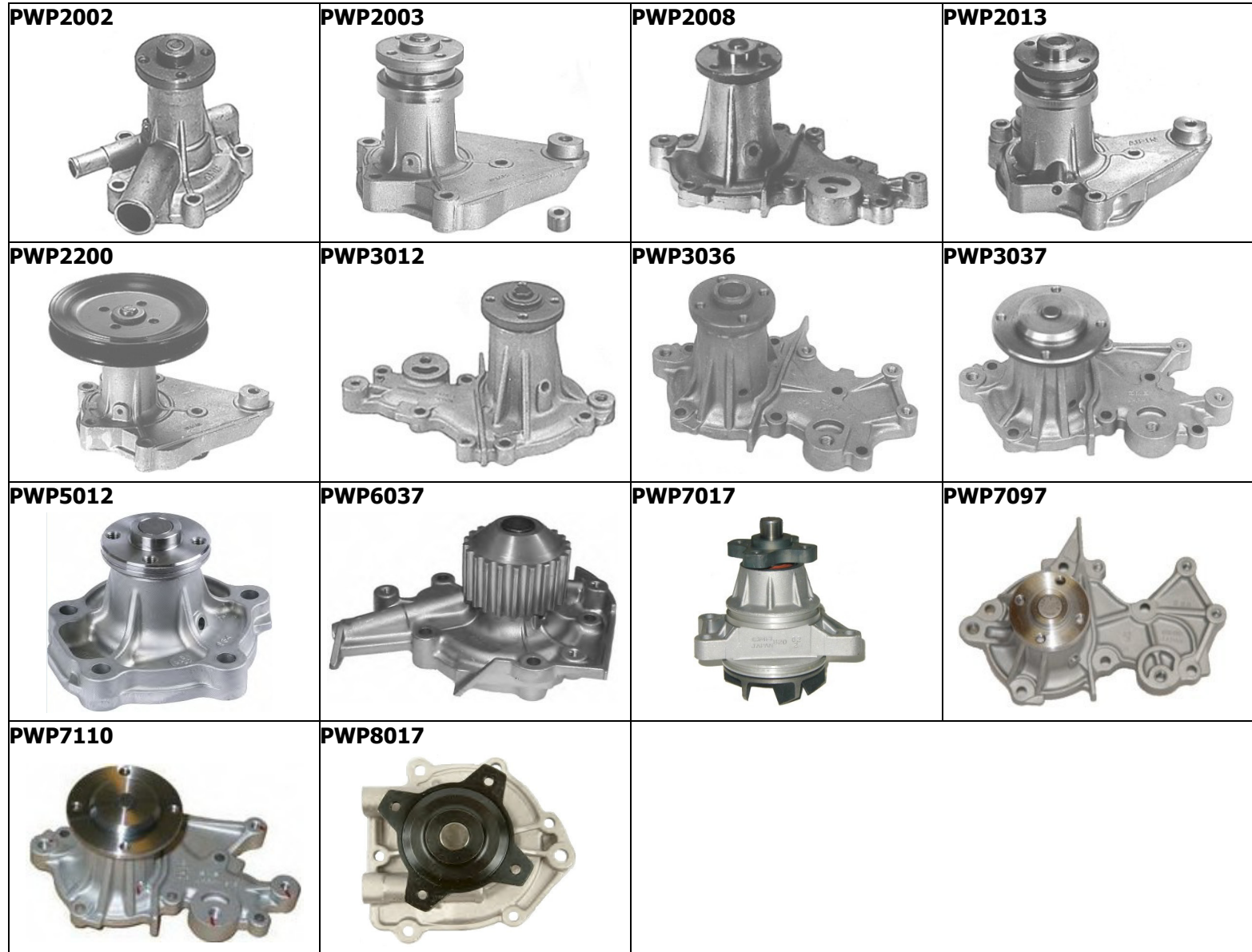

## TOYOTA

Make & Model	Eng Size	Type	Eng Model	Year	Part No.
--------------	----------	------	-----------	------	----------

### 4 Runner

YN60, 63, 130	2.0L		3Y	7/84 - 10/89	<b>PWP894</b>
YN60, 63, 130	2.2L		4Y	10/89 - 6/96	<b>PWP894</b>
YN63, RN130	2.4L		22R	5/89 - 6/96	<b>PWP1064</b>
VNZ130	3.0L	V6	3VZE	10/90 - 8/92	<b>PWP3049</b>
YNZ130	3.0L	V6	3VZE	8/92 - 6/96	<b>PWP3105</b>
LN60, 61	2.4L	Diesel	2L	1984 - 89	<b>PWP1061</b>
LN61, 130	2.8L	Diesel	3L	5/89 - 6/96	<b>PWP3046</b>

### Avalon

MCX10R	3.0L	V6	1MZFE	7/2000 on	<b>PWP7035</b>
--------	------	----	-------	-----------	----------------

### Avensis

ACM20R	2.0L	DOHC	1AZ	12/2001 on	<b>PWP7029</b>
--------	------	------	-----	------------	----------------

### Blizzard

LD10	2.2L	Diesel	L	1982 - 85	<b>PWP819</b>
------	------	--------	---	-----------	---------------

### Bobcat

Bobcat	2.5L	Diesel	3J, 5P		<b>PWP7210</b>
--------	------	--------	--------	--	----------------

### Bundera

RJ70 (Without air con)	2.4L		22R	1985 - 91	<b>PWP842</b>
RJ70 (With air con)	2.4L		22RE	1985 - 91	<b>PWP1064</b>
LJ70	2.4L	Diesel	2L	1985 - 91	<b>PWP1061</b>

### Camry

SV11	2.0L		2S - C	11/85 - 3/87	<b>PWP1053</b>
SV21, 22 (Round tooth)	2.0L		3SGE	5/87 - 1/93	<b>PWP3041</b>
SV21, 22 (Square tooth)	2.0L	DOHC <b>PUMP and HOUSING</b>	3SFE	1/87 - 92	<b>PWP3047 PWP3047A</b>
SV21, 21 (Square tooth)	2.2L	DOHC <b>PUMP and HOUSING</b>	5SFE	5/87 - 02	<b>PWP3047 PWP3047A</b>
VZV20, 21	2.5L	V6	2VZFE	6/88 - 93	<b>PWP3054</b>
VDV10 Vienta	3.0L	V6	3VZFE	2/93 - 7/97	<b>PWP3054</b>
SXV, MCV20	3.0L	V6	1MZ	8/97 - 02/03	<b>PWP7035</b>
36 Series	2.4L	16V DOHC	2AZ	10/02 on	<b>PWP7105</b>

### Celica

TA22 (Fixed fan)	1.6L		2T	1972 - 76	<b>PWP798</b>
TA22 (Fan clutch)	1.6L		2T	1977 - 83	<b>PWP2045</b>
RA23, RA28	2.0L		18RC	1975 - 77	<b>PWP836</b>
RA23, RA28 (Housing only)	2.0L		18RC	1975 - 77	<b>PWP836HO</b>

# PWP2008 WATER PUMP CATALOGUE

## TOYOTA

Make & Model	Eng Size	Type	Eng Model	Year	Part No.
--------------	----------	------	-----------	------	----------

### Celica Continued..

RA23, RA28 (Pump only)	2.0L		18RC	1975 - 77	<b>PWP836PO</b>
RA40	2.0L		18RC	1977 - 81	<b>PWP836</b>
RA40 (Housing only)	2.0L		18RC	1977 - 81	<b>PWP836HO</b>
RA40 (Pump only)	2.0L		18RC	1977 - 81	<b>PWP836PO</b>
RA60	2.0L		21RC	1981 - 83	<b>PWP842</b>
RA65	2.4L		22RC	1984 - 85	<b>PWP842</b>
RA65 (Small impeller)	2.4L		22RE	1985 on	<b>PWP1064</b>
SA63	2.0L		2SC	1983 - 84	<b>PWP1053</b>
ST162	2.0L	DOHC	3SGE	10/85 - 89	<b>PWP9067</b>
ST162 (Square tooth)	2.0L	<b>DOHC PUMP and HOUSING</b>	3SFE	1986 - 88	<b>PWP3047 PWP3047A</b>
ST162 (Round tooth)	2.0L	DOHC	3SGE	1984 - 86	<b>PWP3041</b>
ST184 (Round tooth)	2.2L	<b>DOHC PUMP and HOUSING</b>	5SFE	1989 - 10/91	<b>PWP3047 PWP3047A</b>
ST185	2.0L	DOHC Turbo	3SGTE	10/91 - 2/94	<b>PWP3041</b>
ST204	2.2L	<b>DOHC PUMP and HOUSING</b>	5SFE	4/94 - 11/99	<b>PWP3047 PWP3047A</b>
ST205R	2.0L	DOHC Turbo	3SGTE	4/94 - 11/99	<b>PWP3041</b>
ZZT231	1.8L	16V DOHC	2ZZ	11/99 on	<b>PWP7125</b>

### Coaster

BB13, 20	3.2, 3.4L	Diesel	B, 3B	1980 - 84	<b>PWP9075</b>
BB10, 11	3.2L	Diesel	2B	1982 - 89	<b>PWP885</b>
RB20 (Without air con)	2.4L		22R	1982 - 86	<b>PWP842</b>
BB10	3.2L	Diesel	2B	1978 - 82	<b>PWP885</b>
BB20	3.4L	Diesel	3B	1982 - 88	<b>PWP9075</b>
BB21, 40	3.4L	Diesel	3B	8/88 on	<b>PWP4026</b>
HB30	4.0L	Diesel	2H	1987 - 90	<b>PWP896</b>
HZB30, 50	4.2L	Diesel	1HZ	3/1990 on	<b>PWP3106</b>

### Corolla

KE10, 11, 15, 17, 18	1.1L		3K	1966 - 70	<b>PWP757</b>
KE20, 25, 26	1.2L		3K	1970 - 74	<b>PWP797</b>
KE30, 35, 36	1.2L		3KC	1975 - 77	<b>PWP835</b>
KE30, 35, 36, 50	1.3L		3KC	1977 - 81	<b>PWP859</b>
KE70	1.3L		4KC	1981 - 83	<b>PWP859</b>
KE70 Hi - Cam	1.3L		4KC	1983 - 85	<b>PWP897</b>

## TOYOTA

Make & Model	Eng Size	Type	Eng Model	Year	Part No.
--------------	----------	------	-----------	------	----------

### Corolla Continued..

Sprinter (With fan clutch)	1.6L		2T	1977 - 83	<b>PWP2045</b>
Sprinter (With fixed fan)	1.6L		2T	1972 - 79	<b>PWP798</b>
AE71	1.6L		4AC	1983 - 85	<b>PWP5003</b>
AE80	1.3L		2AC	1985 - 89	<b>PWP1058</b>
AE82 (With fixed fan)	1.6L	Twin cam	4AGE	1985 - 89	<b>PWP1063</b>
AE86 (With fan clutch)	1.6L	Twin cam	4AGE	1983 on	<b>PWP1062</b>
AE86 Sprinter	1.6L		4AC	1983 - 86	<b>PWP1058</b>
AE90	1.6L		4AF	1989 - 92	<b>PWP3039</b>
AE90	1.4L		6AF	1989 - 92	<b>PWP3039</b>
AE92, 95	1.6L	Twin cam	4AGE	1988 - 94	<b>PWP3039</b>
AE92, 93 Seca Inc. 20 Valve Eng.	1.6L	Twin cam	4AGE	6/89 - 94	<b>PWP1063</b>
AE93	1.6L	DOHC	4AFE	7/1991 on	<b>PWP3084</b>
AE93	1.8L	DOHC	7AFE	7/1991 on	<b>PWP3083</b>
AE101, 102	1.6L	DOHC	4AFE	9/94 - 7/98	<b>PWP3084</b>
AE101, 102	1.8L	DOHC	7AFE	9/94 - 7/98	<b>PWP3083</b>
AE112	1.8L	DOHC	7AFE	10/98 - 11/01	<b>PWP3083</b>
ZZE122R	1.8L	DOHC	1ZZFE	12/2001 on	<b>PWP7011</b>
ZZE122, 123R	1.8L	DOHC	2ZZFE	12/2001 on	<b>PWP7125</b>

### Corona

MK2, MX10, MX22	2.0, 2.3L		2M	1973 - 75	<b>PWP732</b>
MK2, MX13, MX23	2.6L		4M	1974 - 77	<b>PWP841</b>
RT40	1.6L		4R	1966 - 71	<b>PWP731</b>
RT40	1.5L		2R	1965 - 71	<b>PWP579</b>
RT80, RT81	1.6L		12R	1971 - 74	<b>PWP959</b>
RT104, 118 (Pump only)	2.0L		18R	1974 - 75	<b>PWP759</b>
RT104, 118 (Single pulley w/fan clutch)	2.0L		18R	1974 - 75	<b>PWP890</b>
RT104, 118 (Twin pulley w/fan clutch)	2.0L		18R	1975 - 79	<b>PWP836</b>
RT104 (Housing only)				1975 - 79	<b>PWP836HO</b>
RT104 (Pump only)	2.0L		18R	1975 - 79	<b>PWP836PO</b>
RT132 Liftback (Pump & fan clutch)	2.0L		18RC	1979 - 81	<b>PWP836</b>
RT132 Liftback (Housing only)				1979 - 81	<b>PWP836HO</b>
RT132 Liftback (Pump only)	2.0L		18RC	1979 - 81	<b>PWP836PO</b>
RT133 Liftback	2.0L		21RC	1981 - 82	<b>PWP842</b>
ST141	2.0L		2S	1983 - 87	<b>PWP1053</b>



# PWP2008 WATER PUMP CATALOGUE

## TOYOTA

Make & Model	Eng Size	Type	Eng Model	Year	Part No.
--------------	----------	------	-----------	------	----------

### Corona Continued..

RT142 Avante	2.4L		22RC	1984 - 87	<b>PWP842</b>
RT142 Avante (Small impeller)	2.4L		22RE	1984 - 87	<b>PWP1064</b>
XT130, XT131	1.9L		Starfire	1979 - 83	<b>PWP814</b>

### Cressida

MX30, 32, 36	2.6L		4M	1977 - 80	<b>PWP841</b>
MX62	2.8L		5ME	1981 - 85	<b>PWP1055</b>
MX73	2.8L		5MGE	1985 - 88	<b>PWP816</b>
MX83	3.0L	DOHC	7MGE	1988 - 92	<b>PWP3042</b>

### Crown

MS50	2.3L		2M	1967 - 71	<b>PWP732</b>
MS111	2.5L		4M	1979 - 83	<b>PWP1055</b>
MS112, 123	2.8L		5ME	1980 - 83	<b>PWP1055</b>
MS125	2.8L		5MGE	1983 - 88	<b>PWP816</b>
MS83, MS85	2.6L		4M	1976 - 79	<b>PWP841</b>
RS40 (Fixed fan)	1.9L		3R	1963 - 73	<b>PWP731</b>
RS40 (Fan clutch)	1.9L		3R	1963 - 73	<b>PWP732</b>
RS50	2.0L		5R	1967 - 71	<b>PWP731</b>

### Dyna

BU10 to 30	3.0, 3.2L	Diesel	B, 2B	1972 - 81	<b>PWP885</b>
BU20, 32, 36, 60, 63	3.0L	Diesel	B	1980 - 88	<b>PWP9075</b>
BU30, 36	3.2L	Diesel	2B	1980 - 84	<b>PWP9075</b>
BU61, 62, 65, 85	3.0, 3.4L	Diesel	11B, 13B	1985 - 95	<b>PWP3038</b>
BU62, 65, 68, 88	3.0, 3.4, 3.7L	Diesel	11B, 13B, 14B	1988 - 95	<b>PWP3078</b>
BU85, 86	3.4L	Diesel	13B	1985 - 91	<b>PWP3038</b>
BU100, 110	3.4L	Diesel	3B	1995 on	<b>PWP3078</b>
BU142, 212, 222	4.1L	Diesel	15B	7/95 on	<b>PWP3078</b>
HU15, 30	3.6L	Diesel	H	1972 - 81	<b>PWP887</b>
HU40, 50	4.0L	Diesel	2H	1982 - 84	<b>PWP896</b>
LH81, LY60, LY61	2.4L	Diesel	2L	1986 - 91	<b>PWP1061</b>
LY161, LY211, LY220	2.8L	Diesel	3L	1989 - 91	<b>PWP3046</b>
RU10, 15	2.0L		5R	1970 - 77	<b>PWP858</b>
RU20, 25, 30	2.0L		5R	1977 - 81	<b>PWP847</b>
YH81, YU60	1.8, 2.0L		2Y, 3Y	1985 - 91	<b>PWP894</b>
YU62	2.2L		4Y	1987 - 91	<b>PWP894</b>

## TOYOTA

Make & Model	Eng Size	Type	Eng Model	Year	Part No.
--------------	----------	------	-----------	------	----------

### Echo

NCP10	1.3, 1.5L		1NZ, 2NZ	9/1999 on	<b>PWP7013</b>
-------	-----------	--	----------	-----------	----------------

### Estima/Lucida

Van, Wagon	2.2L		3CT	11/1995 on	<b>PWP7045</b>
------------	------	--	-----	------------	----------------

### Forklift

Forklift	2.5L	Diesel	3J, 5P		<b>PWP7210</b>
----------	------	--------	--------	--	----------------

### Hiace

RH10, RH11	1.5, 1.6L		12R	1969 - 76	<b>PWP959</b>
RH11, 20	1.6L		12R	1977 - 85	<b>PWP882</b>
RH22, 32, 42	2.0L		18R	1979 - 82	<b>PWP836</b>
RCH SBV	2.4L	OHC	2RZ	10/95 on	<b>PWP1068</b>
RZH103, 113, 125	2.4L		2RZ	1991 - 95	<b>PWP1068</b>
LH20, 30	2.2L	Diesel	L	1981 - 82	<b>PWP819</b>
YH50, 61, 71	2.0L		3Y	1983 on	<b>PWP894</b>
LH11, 30, 50, 51, 61, 71	2.4L	Diesel	2L	1984 - 89	<b>PWP1061</b>
LH103, 113, 125	2.8L	Diesel	3L	1991 - 95	<b>PWP3046</b>
LH162, 172, 184	3.0L	Diesel	5L	11/2000 on	<b>PWP3046</b>

### Hilux

RN10, 15, 20, 25	1.5, 1.6L		2R, 12R	1969 - 76	<b>PWP959</b>
RN20, 22, 25, 30, 40	1.6L		12R	1978 - 80	<b>PWP882</b>
RN27, 31, 36, 41, 46	2.0L	(Complete assy.)	18R	1972 - 75	<b>PWP890</b>
RN27, 31, 36, 41, 46	2.0L	(Pump only)	18R	1972 - 75	<b>PWP759</b>
RN27, 31, 36, 41, 46	2.0L		18R	1979 - 83	<b>PWP836</b>
RN85, 90, 105, 110	2.4L		22R	1988 - 89	<b>PWP842</b>
RN90 to 110 (Small impeller)	2.4L		22R	1989 - 98	<b>PWP1064</b>
YN Series	2.0, 2.2L		3Y, 4Y	1985 - 91	<b>PWP894</b>
LN30, 40, 46, 55	2.2L	Diesel	L	1980 - 86	<b>PWP819</b>
LN56, 61, 65, 85	2.4L	Diesel	2L	1983 - 91	<b>PWP1061</b>
LN106, 111	2.8L	Diesel	3L	1989 on	<b>PWP3046</b>
KZN165 SR5 (Pump & housing)	3.0L	Turbo Diesel	1KZTE	12/1999 on	<b>PWP7018A</b>
KZN165 SR5 (Pump only)	3.0L	Turbo Diesel	1KZTE	12/1999 on	<b>PWP7018PO</b>
RZN149, 169	2.0L	OHC	1RZ	10/97 - 10/01	<b>PWP1068</b>
RZN149, 169	2.7L	DOHC	3RZ	10/97 - 10/01	<b>PWP7008</b>
LN147, 167	3.0L	Diesel	5L	10/97 - 10/01	<b>PWP3046</b>
VZN167	3.4L	V6	5VZFE	11/2002 on	<b>PWP7009</b>
GGN15R	4.0L	V6	IGR-FE	03/03 on	<b>PWP8080</b>

# PWP2008 WATER PUMP CATALOGUE

## TOYOTA

Make & Model	Eng Size	Type	Eng Model	Year	Part No.
--------------	----------	------	-----------	------	----------

### Kluger

MCR20R	3.3L	DOHC V6	3MZ	09/2003 on	<b>PWP7420</b>
--------	------	---------	-----	------------	----------------

### Landcruiser

BJ40	3.0L	Diesel	B	1977 - 79	<b>PWP885</b>
BJ42, 70, 73, 74	3.4L		3B	1981 - 91	<b>PWP3068</b>
FJ40, 45	3.2L		2B	1976 - 82	<b>PWP9075</b>
FJ40, 45, 55 (Conventional fan)	4.2L		2F	1975 - 84	<b>PWP856</b>
FJ40, 45, 55 (With oil cooler)	4.2L		2F	1976 - 80	<b>PWP832</b>
FJ40, 43, 45	3.9L	To eng no. 243297	F	1966 - 69	<b>PWP825</b>
FJ40, 43, 45, 55	3.9L	From eng no. 243298	F	1969 - 75	<b>PWP829</b>
FJ60 (With oil cooler)	4.2L		2F	1980 - 84	<b>PWP832</b>
FJ60 (Conventional fan)	4.2L		2F	1980 - 84	<b>PWP856</b>
FJ60 (With fan clutch)	4.2L		2F	1980 - 84	<b>PWP3056</b>
FJ62, 70, 75 (With fan clutch)	4.0L		3F	1985 - 90	<b>PWP940</b>
FJ62, 70, 75 (Fixed fan)	4.0L		3F	1985 - 90	<b>PWP3051</b>
FJ62, 70, 75 (With fan clutch & oil cooler)	4.0L		3F	1985 - 90	<b>PWP3052</b>
FJ80 (With fan clutch)	4.0L		3F	05/90 - 10/92	<b>PWP940</b>
FJ80 (With fixed fan)	4.0L		3F	03/90 - 10/92	<b>PWP3051</b>
FJ80 EFI (With fan clutch)	4.5L		3FE	1992 on	<b>PWP3052</b>
HJ45	3.6L	Diesel	H	1972 - 80	<b>PWP887</b>
HJ47	4.0L	Diesel	2H	1980 - 84	<b>PWP896</b>
HJ60	4.0L	Turbo Diesel	2HT	1985 on	<b>PWP896</b>
HJ75, PZJ100	4.0L	Diesel	2H	1984 on	<b>PWP896</b>
HZJ75, HZJ79,	4.2L	Diesel	1HZ, 1HD - T	5/93-8/01	<b>PWP3106</b>
HDJ78	4.2L	Diesel	1HZ, 1HD - T	11/99 on	<b>PWP3106</b>
HZJ80, 81	4.2L	Diesel	1HZ, 1HD - T	1989 on	<b>PWP3106</b>
PZJ70, 100	3.5L	Diesel 5cyl.	1PZ	01/90 - 08/91	<b>PWP3106</b>
FZJ75, 80, 100	4.5L		1FZ - FE	1992 on	<b>PWP3107</b>
HDJ100	4.2L	Diesel	1HZ, 1HD - T	03/98 on	<b>PWP3106</b>
UZJ100	4.6L	V8	2UZ - FE	4/1998 on	<b>PWP3104</b>

### Lexcen

VN, VP	3.8 L	V6		9/89 - 8/91	<b>PWP4000A</b>
VP, VR	3.8 L	V6		9/91 - 3/95	<b>PWP4000A</b>
VS to Eng. No. VH515478	3.8L	V6		5/95 - 6/96	<b>PWP4000A</b>
VS from Eng. No. VH515479	3.8L	V6		6/1996 on	<b>PWP4000A</b>

## TOYOTA

Make & Model	Eng Size	Type	Eng Model	Year	Part No.
--------------	----------	------	-----------	------	----------

### Liteace

CM20, 36	1.8, 2.0L	Diesel	1C, 2C	1983 - 91	<b>PWP1200</b>
KM20 (With fixed fan)	1.2, 1.3L		4K, 5K	1982 - 84	<b>PWP1069</b>
KM20, 36 (With fan clutch)	1.2, 1.3L		4K, 5K	1980 - 91	<b>PWP1210</b>
YM21, 30, 35, 40, 41	1.8L		2Y	01/84 - 09/87	<b>PWP894</b>

### MR2

AW11	1.6L	DOHC	4AGE	1989 - 90	<b>PWP1063</b>
SW20	2.0L	DOHC	3SGE	1990 - 93	<b>PWP3041</b>
ZZW30R	1.8L	DOHC	1ZZFE	10/2002 on	<b>PWP7011</b>

### Paseo

EL44 (With pressed on pulley)	1.5L	DOHC	5E & EF	6/91 - 11/95	<b>PWP7036</b>
EL45	1.5L	DOHC	5E & EF	11/95 - 12/99	<b>PWP3085</b>

### Prado

KZJ90, KZJ95, VZJ90, VZJ95	2.7L	4 Cyl.	3RZFE	96 - 01/03	<b>PWP7008</b>
KZJ90, KZJ95, VZJ90, VZJ95	3.4L	6 Cyl.	5VZFE	96 - 01/03	<b>PWP7009</b>
RZJ90 (Pump & housing)	3.0L	Turbo Diesel	1KZTE	9/90 - 01/03	<b>PWP7018A</b>
RZJ90 (Pump only)	3.0L	Turbo Diesel	1KZTE	9/90 - 01/03	<b>PWP7018PO</b>
GRJ120	2.7L	4 Cyl.	3RZFE	02/2003 on	<b>PWP7008</b>
GRJ120 (Pump only)	3.0L	Turbo Diesel	1KZTE	02/2003 on	<b>PWP7018PO</b>
GRJ120 (Pump & housing)	3.0L	Turbo Diesel	1KZTE	02/2003 on	<b>PWP7018A</b>
GRJ120	4.0L	V6	1GR - FE	02/2003 on	<b>PWP8080</b>

### Prius

NHW11R	1.5	DOHC	1NZ	09/01 on	<b>PWP7013</b>
--------	-----	------	-----	----------	----------------

### Rav 4

SXA10, 11	2.0L	<b>PUMP and HOUSING</b>	3SFE	7/94 - 6/00	<b>PWP3047</b> <b>PWP3047A</b>
ACA20, 21	2.0L	DOHC	1AZ	7/00 on	<b>PWP7105</b>

### Soarer

SC400	4.0L	V8	1UZ	01/90 - 12/97	<b>PWP3104</b>
JZZ30	2.5L	Twin Turbo	1JZ	12/92 - 8/96	<b>PWP7042</b>
JZZ30	2.5L	Twin Turbo	1JZ	9/1996 on	<b>PWP9999</b>
JZZ31, JZX90, 91, 93, 101, 105	3.0L	DOHC	2JZ	1991 on	<b>PWP7010</b>

### Spacia

YR22	2.2L		4Y	10/93 - 8/96	<b>PWP894</b>
SR40	2.0L	DOHC	3SFE	2/98 on	<b>PWP3047</b>

### Sprinter

AE102R	1.8L	DOHC	7AFE	5/94 - 6/96	<b>PWP3083</b>
--------	------	------	------	-------------	----------------

# PWP2008 WATER PUMP CATALOGUE

## TOYOTA

Make & Model	Eng Size	Type	Eng Model	Year	Part No.
--------------	----------	------	-----------	------	----------

### Starlet

EP9	1.3L		4E - FE	4/1996 on	<b>PWP3085</b>
EP9 (With pressed on pulley)	1.5L	DOHC	5E, 5EF	4/96 - 11/95	<b>PWP7036</b>

### Stout

RK101	2.0L		5R	1971 - 75	<b>PWP858</b>
RX101, RK110	2.0L		5R	1975 - 81	<b>PWP847</b>

### Supra

MA61	2.8L		5ME	1983 - 86	<b>PWP1055</b>
MA70	2.8L		5MGE	1986 - 90	<b>PWP816</b>
MA70, 71 Inc. Turbo	3.0L	DOHC	7MGE	1986 - 12/92	<b>PWP3042</b>
JZS141, 143, 145, 47, 149	3.0L	DOHC	2JZ	1995 - 00	<b>PWP7010</b>
JZS141, 143, 145, 47, 149	3.0L	Twin Turbo	2JZ	5/1993 on	<b>PWP7042</b>
JZA80	2.5L	Twin Turbo	1JZ	12/92 - 8/96	<b>PWP7042</b>

### T18

TE72 Liftback	1.8L		3TC	10/79 - 07/83	<b>PWP3308</b>
---------------	------	--	-----	---------------	----------------

### Tarago

YR20	1.8, 2.0L		2Y, 3Y	1983 - 89	<b>PWP894</b>
CR21	2.0L	Diesel	2C	1983 - 88	<b>PWP1200</b>
CR22, 29, 31, 38	2.2L	Diesel	3C - T	9/93 - 10/96	<b>PWP7045</b>
YR22, 31	2.2L		4Y	1986 - 90	<b>PWP894</b>
TCR1#, 2# (Pump only)	2.4L	DOHC	2TZ	1990 - 5/00	<b>PWP3132</b>
ACR30	2.4L	DOHC	2AZ - FE	6/2000 on	<b>PWP7105</b>

### Tercel

AL25	1.5L		3AC	1983 on	<b>PWP5002</b>
------	------	--	-----	---------	----------------













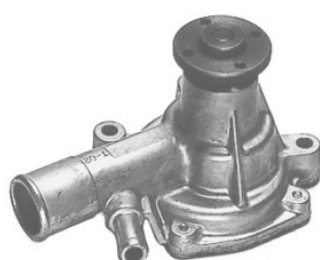
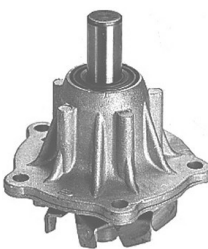

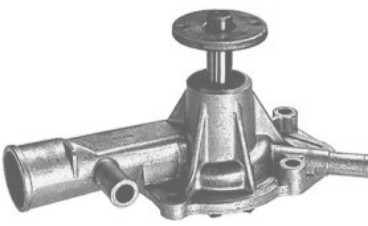

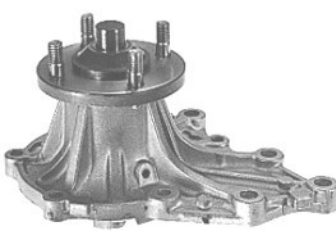
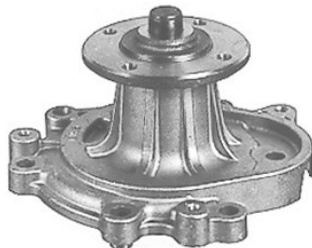
### Toyoace

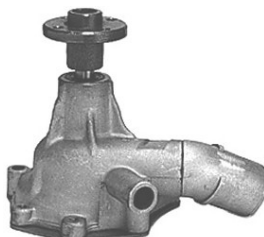
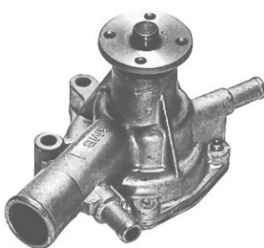
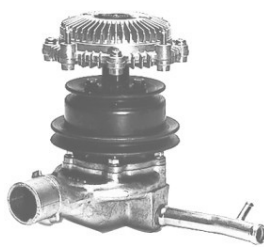
RY31	2.0L		5R	1980 - 85	<b>PWP847</b>
LY30	2.2L	Diesel	L	1982 - 83	<b>PWP819</b>
LY31	2.4L	Diesel	2L	1983 - 85	<b>PWP1061</b>
YR39	2.0L		3Y	1992 - 12/96	<b>PWP894</b>
KR42, 43 SBV	1.8L		7K	1/1997 on	<b>PWP1210</b>

### Yaris

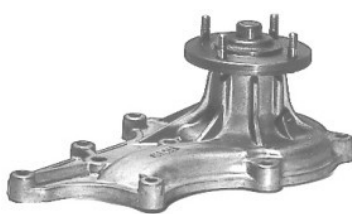
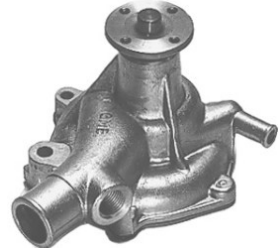

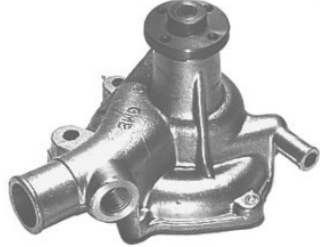

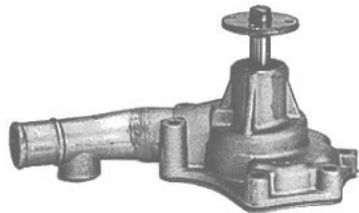





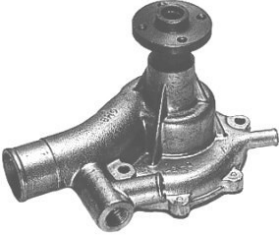

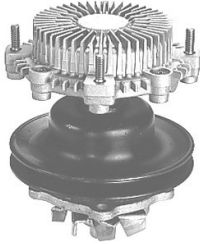

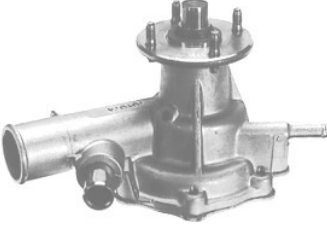

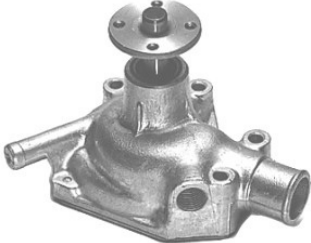
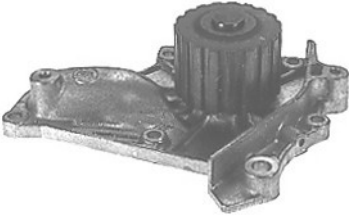
Yaris	1.3L		2NZ	09/05 on	<b>PWP7013</b>
Yaris	1.5L	DOHC	1NZ	09/05 on	<b>PWP7013</b>

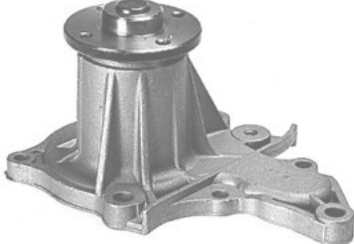
**TOYOTA**

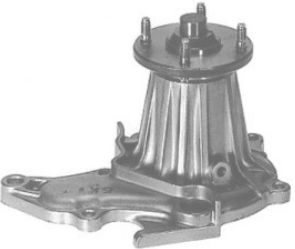

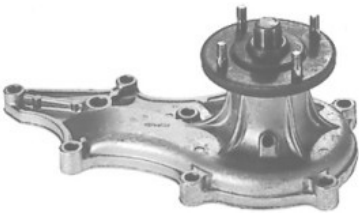
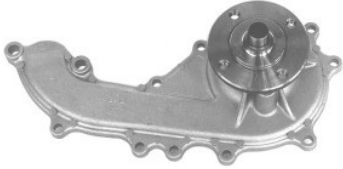
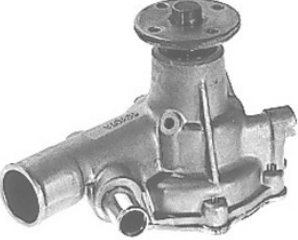
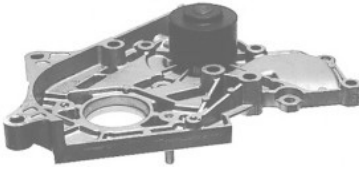
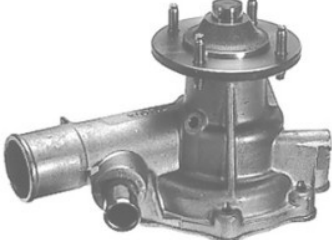
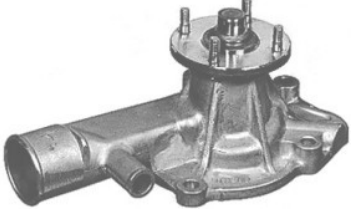

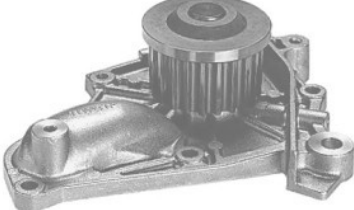





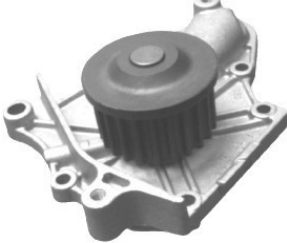

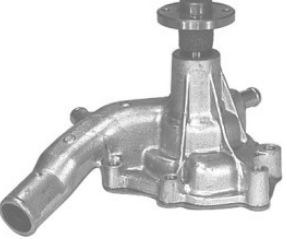
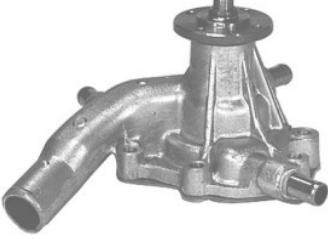

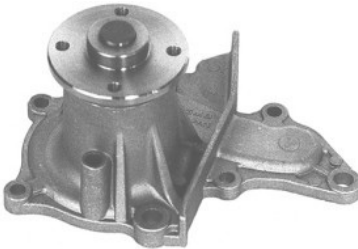

Make & Model	Eng Size	Type	Eng Model	Year	Part No.
<b>PWP579</b> 	<b>PWP731</b> 	<b>PWP732</b> 	<b>PWP757</b> 		
<b>PWP759</b> 	<b>PWP797</b> 	<b>PWP798</b> 	<b>PWP814</b> 		
<b>PWP816</b> 	<b>PWP819</b> 	<b>PWP825</b> 	<b>PWP829</b> 		
<b>PWP832</b> 	<b>PWP835</b> 	<b>PWP836</b> 	<b>PWP836HO</b> 		
<b>PWP836PO</b> 	<b>PWP841</b> 	<b>PWP842</b> 	<b>PWP847</b> 		
<b>PWP856</b> 	<b>PWP858</b> 	<b>PWP859</b> 	<b>PWP882</b> 		

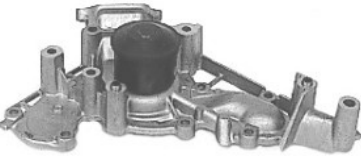
# PWP2008 WATER PUMP CATALOGUE

**TOYOTA**

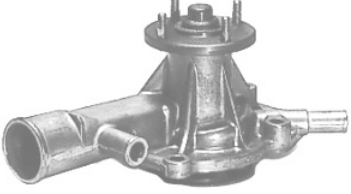
Make & Model	Eng Size	Type	Eng Model	Year	Part No.
<b>PWP885</b> 	<b>PWP887</b> 	<b>PWP890</b> 			<b>PWP894</b> 
<b>PWP896</b> 	<b>PWP897</b> 	<b>PWP940</b> 			<b>PWP959</b> 
<b>PWP1053</b> 	<b>PWP1055</b> 	<b>PWP1058</b> 			<b>PWP1061</b> 
<b>PWP1062</b> 	<b>PWP1063</b> 	<b>PWP1064</b> 			<b>PWP1068</b> 
<b>PWP1069</b> 	<b>PWP1200</b> 	<b>PWP1210</b> 			<b>PWP2045</b> 
<b>PWP3038</b> 	<b>PWP3039</b> 	<b>PWP3041</b> 			<b>PWP3042</b> 

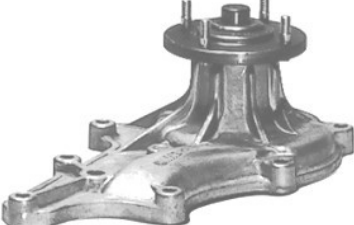
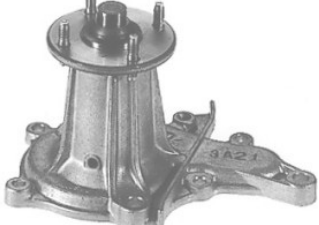
**TOYOTA**

Make & Model	Eng Size	Type	Eng Model	Year	Part No.
<b>PWP3046</b> 	<b>PWP3047</b> 	<b>PWP3047A</b> 			<b>PWP3049</b> 
<b>PWP3051</b> 	<b>PWP3052</b> 	<b>PWP3054</b> 			<b>PWP3056</b> 
<b>PWP3068</b> 	<b>PWP3078</b> 	<b>PWP3083</b> 			<b>PWP3084</b> 
<b>PWP3085</b> 	<b>PWP3104</b> 	<b>PWP3105</b> 			<b>PWP3106</b> 
<b>PWP3107</b> 	<b>PWP3132</b> 	<b>PWP3308</b> 			<b>PWP4000A</b> 
<b>PWP4026</b> 	<b>PWP5002</b> 	<b>PWP5003</b> 			<b>PWP7008</b> 



# PWP2008 WATER PUMP CATALOGUE

## TOYOTA

Make & Model	Eng Size	Type	Eng Model	Year	Part No.
<b>PWP7009</b>	<b>PWP7010</b>	<b>PWP7011</b>	<b>PWP7013</b>		
					
<b>PWP7018A</b>	<b>PWP7018PO</b>	<b>PWP7029</b>	<b>PWP7035</b>		
		<i>Photo Not Available</i>			
<b>PWP7036</b>	<b>PWP7042</b>	<b>PWP7045</b>	<b>PWP7105</b>		
					
<b>PWP7125</b>	<b>PWP7210</b>	<b>PWP7420</b>	<b>PWP8011</b>		
			<i>Photo Not Available</i>		
<b>PWP8080</b>	<b>PWP9067</b>	<b>PWP9075</b>	<b>PWP9999</b>		
					

## TRIUMPH

Make & Model	Eng Size	Type	Eng Model	Year	Part No.
<b>2000/2500</b>					
2000, 2500 MK1 & 2	2.0, 2.5L		ME, MG	1965 - 78	<b>PWP749</b>
<b>GT6</b>					
GT6 Coupe	2.0, 2.5L		KC	1967 - 73	<b>PWP749</b>
<b>TR5</b>					
TR5	2.0, 2.5L			1968 - 75	<b>PWP749</b>

### PWP749



## VOLKSWAGEN

Make & Model	Eng Size	Type	Eng Model	Year	Part No.
<b>Beetle</b>					
Beetle	2.0L		AQY	1/2000 on	<b>PWP7078</b>
<b>Bora</b>					
Bora Sedan	2.0L		APK	12/1999 on	<b>PWP7078</b>
Bora Sedan	2.3L	V5	AGZ	12/1999 on	<b>PWP7082</b>
Bora Sedan	2.8L	V6	AUE	12/1999 on	<b>PWP7083</b>
<b>Golf</b>					
Golf A1	1.6L			3/77 - 12/82	<b>PWP952</b>
Golf (Pump only)	1.5L	Diesel		1978 - 82	<b>PWP952</b>
Golf GTi	1.8L		RV	1990 - 3/94	<b>PWP2453</b>
Golf A2	2.0L		ADY	1994 on	<b>PWP2453</b>
Golf A2	1.8L		ADZ	1994 on	<b>PWP2453</b>
Golf	2.8L		AAA	3/94 - 10/98	<b>PWP7083</b>
Golf	1.9L	Diesel	1Y	1994 - 9/98	<b>PWP2453</b>
Golf	1.6L		AEH	9/1998 on	<b>PWP7079</b>
Golf	1.8L		AGN	9/1998 on	<b>PWP7078</b>
Golf Inc. Turbo	1.8L		AGN	9/1998 on	<b>PWP7078</b>
Golf	2.0L		2E	9/1998 on	<b>PWP2453</b>

# PWP2008 WATER PUMP CATALOGUE

## VOLKSWAGEN

Make & Model	Eng Size	Type	Eng Model	Year	Part No.
<b>Passat</b>					
4 Door Sedan	1.5, 1.6L			1974 - 78	<b>PWP952</b>
5 Door Wagon	1.5, 1.6L			1974 - 81	<b>PWP952</b>
Coupe	1.3L			1974 - 75	<b>PWP952</b>
Sedan & Wagon		Diesel		1980 - 82	<b>PWP952</b>
TS Coupe	1.5L			1974 - 75	<b>PWP952</b>
Sedan, Wagon	2.0L		ADY	7/95 - 3/97	<b>PWP2453</b>
Sedan, Wagon	2.8L	V6	AAA	7/95 - 3/97	<b>PWP7083</b>
Sedan, Wagon			AHG, AHU, 1Z	92 - 97	<b>PWP2453</b>
Sedan Inc. Turbo	1.8L		ADR,AEB	2/98 - 12/00	<b>PWP4003</b>
Sedan	2.8L	V6	ACK	2/98 - 12/00	<b>PWP7088</b>

<b>Polo</b>					
Polo 4 door Hatch	1.4L		AHW	12/1996 on	<b>PWP7085</b>
Polo 4 door Hatch	1.6L	16 Valve	AEE	12/1996 on	<b>PWP7091</b>







<b>Touareg</b>					
Touareg 7L Wagon	13.2L	V6 DOHC	AZZ	03/2007 on	<b>PWP8007</b>

<b>Transporter</b>					
Kombi	1.9L		DH	1/84 - 3/85	<b>PWP7003</b>
Kombi Inc. 4X4 Syncro	2.1L		MY	1985 - 10/92	<b>PWP7084</b>
Transporter 2.0i	2.0L		AAC	11/1992 on	<b>PWP2453</b>
Transporter 2.4TDi.	2.4L	Diesel	AAB	1993 on	<b>PWP4034</b>
Transporter 2.5i	2.5L	5 cyl.	AAF	11/1992 on	<b>PWP7086</b>

<b>Vento</b>					
Vento sedan	2.0L		2E	5/95 - 3/97	<b>PWP2453</b>



## VOLKSWAGEN

Make & Model	Eng Size	Type	Eng Model	Year	Part No.
<b>PWP7083</b> 	<b>PWP7084</b> 	<b>PWP7085</b> 	<b>PWP7086</b> 		
<b>PWP7088</b> 	<b>PWP7091</b> 				

## VOLVO

Make & Model	Eng Size	Type	Eng Model	Year	Part No.
<b>140 Series</b>					
142, 144, 145	1.8, 2.0L		B18, 20, 20E	1967 - 75	<b>PWP976</b>
<b>240 Series</b>					
240	2.3L		B23E	1983 - 86	<b>PWP969</b>
240	2.3L		B230K	3/86 - 9/93	<b>PWP922</b>
242	2.3L		B23E	1979 - 81	<b>PWP969</b>
244	2.1, 2.3L		B21, 23E	1978 - 83	<b>PWP969</b>
245	2.1, 2.3L		B21E, 23E	1975 - 83	<b>PWP969</b>
<b>360 Series</b>					
360	1.9L.		B19E	1984 - 87	<b>PWP969</b>
360	2.0L		B200E	1/85 - 12/85	<b>PWP2566</b>
360	2.0L		B200EA	1/86 - 1/88	<b>PWP2544</b>
<b>440 Series</b>					
440	2.0L		B20E	11/93 - 9/96	<b>PWP998</b>
<b>740 Series</b>					
740	2.3L		B23E	4/83 - 7/84	<b>PWP969</b>
740 Inc. Turbo	2.3L	OHC	B200, 300	6/85 - 12/91	<b>PWP922</b>
740	2.3L	DOHC	230E	6/85 - 12/91	<b>PWP922</b>
<b>760 Series</b>					
760	2.8L	V6	B28E	2/83 - 1/90	<b>PWP923</b>
760	2.3L	OHC	B230E	2/83 - 12/89	<b>PWP922</b>

# PWP2008 WATER PUMP CATALOGUE

**VOLVO**

Make & Model	Eng Size	Type	Eng Model	Year	Part No.
--------------	----------	------	-----------	------	----------

## 850 Series

850	2.4, 2.5L	20V DOHC 5cyl	B5254	1991 - 97	<b>PWP7089</b>
850 Turbo	2.3L	DOHC	B5234T	10/95 - 3/97	<b>PWP7089</b>

## 940 Series

940 Inc. Turbo	2.3L		B234F	11/90 - 10/96	<b>PWP922</b>
----------------	------	--	-------	---------------	---------------

## 960 Series

960	2.8L	V6	B280F	11/90 - 10/94	<b>PWP923</b>
960	2.9L	DOHC 24V	B6304F	11/90 - 2/97	<b>PWP7092</b>

## C Series

C70 Inc. Turbo	2.3, 2.4L	5CYL.	B5252S	4/97 on	<b>PWP7089</b>
----------------	-----------	-------	--------	---------	----------------

## S Series

S40 Inc. Turbo	1.8, 1.9L	DOHC	B4184, B4194	3/97 on	<b>PWP7089</b>
S60 Inc. Turbo	2.3, 2.4L	DOHC	B5244S	11/00 on	<b>PWP7089</b>
S60 Inc. Turbo	2.5L	DOHC 20V	B5254T	11/00 on	<b>PWP7089</b>
S70 Inc. Turbo	2.3, 2.4L	5CYL.	B5234, B5244	4/97 on	<b>PWP7089</b>
S80 Inc. Turbo	2.8, 2.9L	DOHC	B6304F	7/98 on	<b>PWP7092</b>
S90	2.9L	DOHC 24V	B6304F	3/97 - 6/98	<b>PWP7092</b>

## V Series

V40 Inc. Turbo	1.8, 1.9L	DOHC	B5204F	3/1997 on	<b>PWP7089</b>
V70 Inc. Turbo	2.3, 2.4L	5CYL.	B5244	4/1997 on	<b>PWP7089</b>
V70 Inc. Turbo	2.5L	DOHC 20V	B5254	3/2000 on	<b>PWP7089</b>
V90	2.9L	DOHC 24V	B6304F	3/97 - 6/98	<b>PWP7092</b>

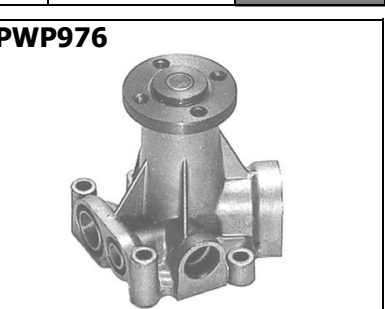

## VOLVO

Make & Model	Eng Size	Type	Eng Model	Year	Part No.
--------------	----------	------	-----------	------	----------

